



# HD-10P<sup>TM</sup> *Series V*

Industrial Tub Grinder  
Serial Number HI0478 & Up

## Manual 1: Operating Instructions





 **DURATECH<sup>®</sup>**  
*Clearing the Way for a Better Tomorrow*



# **HD-10P**<sup>TM</sup> *Series V*

## **Industrial Tub Grinder Serial Number HI0478 & Up**

# **Manual 1: Operating Instructions**

DuraTech Industries International Inc.(DuraTech) has made every effort to assure that this manual completely and accurately describes the operation and maintenance of the HD-10P<sup>TM</sup> Industrial Tub Grinder as of the date of publication. DuraTech reserves the right to make updates to the machine from time to time. Even in the event of such updates, you should still find this manual to be appropriate for the safe operation and maintenance of your unit.

This manual, as well as materials provided by component suppliers to DuraTech are all considered to be part of the information package. Every operator is required to read and understand these manuals, and they should be located within easy access for periodic review.

 **DURATECH**<sup>®</sup> is a registered trademark of Duratech Industries International, Inc.

HD-10P is a trademark of Duratech Industries International, Inc.

---



 **DURATECH<sup>®</sup>**  
*Clearing the Way for a Better Tomorrow*



## Foreword

### **All personnel must read and understand before operating unit**

DuraTech Industries International Inc.(DuraTech) has made every effort to assure that this manual completely and accurately describes the operation and maintenance of this Industrial Grinder as of the date of publication. DuraTech reserves the right to make updates to the machine from time to time. Even in the event of such updates, you should still find this manual to be appropriate for the safe operation and maintenance of your machine.

This manual, as well as materials provided by component suppliers to DuraTech Industries are all considered to be part of the information package. Every operator is required to read and understand these manuals All manuals should be located within easy access for troubleshooting and periodic review.

### **Appropriate use of the unit**

This Industrial Grinder is designed to grind wood waste and other materials, including grass clippings, leaves, construction and demolition debris, tree branches and tree trunks It is **NOT** designed to grind rocks, steel, concrete, or the like.

### **Operator protection**

As with all machinery, care needs to be taken by the operator in order to insure the safety of the operator and those in the surrounding area.



**WARNING:** Operators and those observing the operation of the Industrial Grinder are required to wear head, eye, and ear protection. No loose clothing is allowed.



# Contents

<b>Part 1: Operating Instructions .....</b>	<b>1</b>
<b>Introduction .....</b>	<b>2</b>
<b>Purpose .....</b>	<b>2</b>
<b>How to use this manual .....</b>	<b>2</b>
<b>Section 1: Safety .....</b>	<b>4</b>
1.1 Safety-alert symbols .....	4
1.2 Operator - personal equipment .....	6
1.3 Machine safety labels .....	7
1.4 Shielding .....	10
1.5 Industrial Tub Grinder safety review .....	10
1.6 Thrown objects and operator safety .....	11
1.7 Service and maintenance .....	12
1.8 Personal protection equipment .....	13
1.9 Fire Prevention .....	13
1.10 Fire extinguishers .....	14
1.11 Important safety reminders .....	15
1.12 Towing .....	15
<b>Section 2: Introduction .....</b>	<b>17</b>
2.1 Description of the DuraTech Industrial Tub Grinder .....	17
2.2 Electronic governor .....	18
2.3 Rotor clutch .....	19
2.4 Friction disc torque limiter .....	19
2.5 Rotor .....	19
2.6 Screens .....	19
2.7 Tub .....	19
2.8 The conveyor system .....	20
2.9 Magnetic roller (optional) .....	20
2.10 Mill grate (optional) .....	20
2.11 Hydraulic cooler .....	20
2.12 Tub cover (optional) .....	20
<b>2.13 Overview of the HD-10P operator controls .....</b>	<b>21</b>
2.13.1 Control Panel .....	21
2.13.2 Other operator controls .....	22



## TABLE OF CONTENTS

<b>Section 3: Operation .....</b>	<b>23</b>
3.1 Pre-operation inspection .....	23
3.2 Starting the Industrial Tub Grinder .....	24
3.3 If the engine fails to start .....	25
3.4 Throttle operation .....	25
3.5 Automatic engine shutdown system .....	25
3.6 Normal shutdown procedure .....	26
3.7 Emergency shutdown procedure .....	27
3.8 Murphy System Operation .....	28
3.9 Parts of the electronic governor .....	29
3.10 Operation of the electronic governor .....	30
3.11 Calibration of the electronic governor .....	31
3.12 Adjusting the tub's rotation speed .....	31
3.13 Raising the tub .....	32
3.14 Lowering the tub .....	33
3.15 Starting and stopping the belly and discharge conveyors .....	33
3.16 Lifting the discharge conveyor .....	33
3.17 Operating the grinder using the remote radio option .....	34
3.18 Grinding .....	37
3.19 Loading the tub .....	37
3.19 A Grinding with tub cover .....	38
3.20 If lodging occurs while grinding .....	38
3.21 Grinding wet material .....	38
3.22 Preparing the HD-10P for transport .....	38
3.23 Preparing the HD-10P for operation after transport .....	40
3.24 Preparing the HD-10P for storage .....	40
3.25 Removing the HD-10P from storage .....	41
3.26 Installing a screen .....	41
3.27 Adjusting the conveyor belt tension .....	42
3.28 Adjusting the conveyor belt tracking .....	43
3.29 Sizing the tub drive chain .....	44
3.30 Adjusting tub chain tension .....	45
3.31 Checking for wear on the friction disc torque limiter .....	46
3.32 Engaging and adjusting the rotor clutch .....	47
3.33 Electro-hydraulic valve coil test .....	48
3.34 Electro-hydraulic valve calibration .....	49



## TABLE OF CONTENTS

<b>Section 4: Engine Maintenance .....</b>	<b>50</b>
<b>Section 5: General Maintenance .....</b>	<b>50</b>
5.1 Welding Procedure .....	50
5.2 Batteries .....	51
5.3 Lubrication .....	51
5.4 Pressure roller lubrication .....	54
5.5 Rotor bearing lubrication .....	54
5.6 Hydraulic system .....	54
5.7 Axle, wheels and tires .....	55
5.8 Brake component lubrication .....	55
5.8 Rotor bearing installation .....	57
5.9 Rotor bearing maintenance .....	59
5.10 Hammermill maintenance .....	60
5.11 Fixed hammer maintenance and replacement .....	61
5.12 Swinging hammer replacement and maintenance .....	62
<b>Section 6: Troubleshooting the HD-10P .....</b>	<b>66</b>
6.1 Troubleshooting the electronic governor system .....	66
6.2 General Troubleshooting .....	71
6.3 Troubleshooting Microtronics wireless remote controls .....	72
6.4 Troubleshooting Omnex Wireless Remote Controls .....	76
<b>Appendix A: Warranty .....</b>	<b>79</b>
<b>Appendix B: SPECIFICATIONS .....</b>	<b>80</b>
<b>Appendix C: Operator Training Form .....</b>	<b>83</b>





**HD-10P**<sup>TM</sup> *Series V*

**Industrial Tub Grinder  
Serial Number H10478 & Up**

**Manual 1:  
Operating Instructions**



# Introduction

This Industrial Grinder is designed to grind wood waste and other materials, including grass clippings, leaves, construction and demolition debris, tree branches and tree trunks. It is **NOT** designed to grind rocks, steel, concrete, or the like.

## Purpose

The purpose of this owner's manual is to explain maintenance requirements and routine adjustments for the most efficient operation of your HD-10P. There is also a trouble shooting section that may help in case of problems in the field. Any information not covered in this manual may be obtained from your dealer.



**SPECIAL NOTE:** When reference is made as to front, rear, left hand, or right hand of this machine, the reference is always made from standing at the rear end of the machine and looking toward the hitch. Always use serial number and model number when referring to parts or problems. Please obtain your serial number and write it below for your future reference.

MODEL: HD-10P

SERIAL NO. \_\_\_\_\_

## How to use this manual

### Manual organization

This manual is organized into the following parts:

- **Manual 1: Operating instructions** explain how to set up, use and maintain the HD-10P Industrial Tub Grinder.
- **Manual 2: Parts reference** contains diagrams of each assembly with the number of each part identified. A key on the facing page contains a description of the part and the quantity used.

### Dealer responsibilities

- Thoroughly review this section, "Dealer Responsibilities," and perform the tasks outlined. Also perform a daily pre-operation inspection as described in Section 3, "Operation."
- Upon delivery of the unit to the customer, it is the dealer's responsibility to conduct a training session on the safe operation of the unit for the primary operator(s). Dealer must also conduct a "walk-around" inspection of all safety instructional decals on the machine itself. Decals are illustrated in **Manual 2: Parts Reference**.
- When dealer is satisfied that the primary operators have read the operating instructions, and understand all information concerning the safe operation of the unit, sign and return the User Training Verification Form found in the HD-10P documentation packet.



**NOTE:** This form requires both the dealer's signature and the signatures of up to four primary operators.

- Complete and return the Delivery Notification Form found in the HD-10P documentation packet. Receipt of this form is required to activate the warranty. Appendix A provides details of the warranty.

## **Operator responsibilities**

- The operator is responsible for his own safety.
- The operator is responsible for the safety of all others in the area.
- Review "Dealer Responsibilities," to verify that the machine has been prepared for use.
- Note the important safety information in the Foreword and in Section 1, "Safety."
- Thoroughly review sections 1 through 3 which explain normal operation of the machine, and section 4 and 5 which explain maintenance requirements. These sections will function as a textbook during the dealer-conducted training course that is required before use of the unit.
- When all primary operators have read the operating instructions and understand all information concerning the safe operation of the unit, the dealer will be required to sign the User Training Verification Form found the HD-10P documentation packet.



**NOTE:** This form requires both the dealer's signature and the customer's signature. The dealer is responsible for returning the signed form to DuraTech Industries.

- Manuals for certain third-party components are provided separately. The operator must also be familiar with their contents.
- Keep copies of all manuals in a readily-accessible location for future reference.



# Section 1: Safety

Thank you for taking the time to read the operation and maintenance manual for the DuraTech HD-10P Industrial Tub Grinder. Because your safety and that of others is of the utmost importance, you should familiarize yourself with this entire manual before operating this unit.

The HD-10P incorporates a number of third party products. For example, the engine, and clutch are third party products. More information about the operation and care of these products can be found in each product's respective manual(s). Before operating this unit, you should familiarize yourself with these manuals as well.

Safety is an ongoing job experience, and DuraTech has made every effort to make sure that the HD-10P Industrial Tub Grinder provides operator security and comfort. DuraTech encourages you to bring to our attention as quickly as possible any suggestions you may have concerning the safety of the equipment. DuraTech is dedicated to enhancing the safety of the DuraTech HD-10P Industrial Tub Grinder.

This unit is supplied with an operation and maintenance manual and this manual should be kept with the unit for periodic review by operational personnel.

Operators of the HD-10P are required to wear head, eye, and ear protection as well as clothing appropriate for the application. Individuals with loose clothing, unrestrained long hair, jewelry, or other accessories which may hang loosely away from the body should not be allowed on or near the machine.



**WARNING:** FAILURE TO COMPLY WITH SAFETY INSTRUCTIONS THAT FOLLOW WITHIN THIS MANUAL COULD RESULT IN SEVERE PERSONAL INJURY OR DEATH. BEFORE ATTEMPTING TO OPERATE THIS MACHINE, CAREFULLY READ ALL INSTRUCTIONS CONTAINED WITHIN THIS MANUAL.

**THIS MACHINE IS NOT TO BE USED FOR ANY PURPOSE OTHER THAN THOSE EXPLAINED IN THE OPERATOR'S MANUAL, ADVERTISING LITERATURE OR OTHER DURATECH WRITTEN MATERIAL PERTAINING TO THE HD-10P.**

## 1.1 Safety-alert symbols

Decals are illustrated in **Manual 2: Parts Reference**.

The safety decals located on your machine contain important and useful information that will help you operate your equipment safely.

To assure that all decals remain in place and in good condition, follow the instructions below:

- Keep decals clean. Use soap and water - not mineral spirits, adhesive cleaners and other similar cleaners that will damage the decal.
- Replace all damaged or missing decals. When attaching decals, surface temperature of the machine must be at least 40° F (5° C). The surface must be also be clean and dry.
- When replacing a machine component to which a decal is attached, be sure to also replace the decal.
- Replacement decals can be purchased from your DuraTech dealer.



DuraTech uses industry accepted ANSI standards in labeling its products for safety and operational characteristics.



## Safety-Alert Symbol

Read and recognize safety information. Be alert to the potential for personal injury when you see this safety-alert symbol.

**DANGER:** Indicates an imminently hazardous situation that, if not avoided, will result in death or serious injury. This signal word is to be limited to the most extreme situations, typically for machine components that, for functional purposes, cannot be guarded.



**DANGER:**  
Signal word - White Lettering/Red Background  
Safety Alert Symbol - White Triangle/Red Exclamation Point

**WARNING:** Indicates a potentially hazardous situation that, if not avoided, could result in death or serious injury, and includes hazards that are exposed when guards are removed. It may also be used to alert against unsafe practices.



**WARNING:**  
Signal word - Black Lettering/Orange Background  
Safety Alert Symbol - Black Triangle/Orange Exclamation Point

**CAUTION:** Indicates a potentially hazardous situation that, if not avoided, may result in minor or moderate injury. It may also be used to alert against unsafe practices.



**CAUTION:**  
Signal word - Black Lettering/Yellow Background  
Safety Alert Symbol - Black Triangle/Yellow Exclamation Point

This manual uses the symbols to the right to denote important safety instructions and information.

The **DANGER**, **WARNING** and **CAUTION** symbols are used to denote conditions as stated in the text above. Furthermore, the text dealing with these situations is surrounded by a box with a white background, will begin with **DANGER**, **WARNING**, or **CAUTION**.

The **INFORMATION** symbol is used to denote important information or notes in regards to maintenance and use of the machine. The text for this information is surrounded by a box with a light grey background, and will begin with either **IMPORTANT** or **NOTE**.





## 1.2 Operator - personal equipment

### THE OPERATOR

#### Physical Condition

You must be in good physical condition and mental health and not under the influence of any substance (drugs, alcohol) which might impair vision, dexterity or judgment.

Do not operate a **HD-10P** when you are fatigued. Be alert - If you get tired while operating your **HD-10P**, take a break. Fatigue may result in loss of control. Working with any farm equipment can be strenuous. If you have any condition that might be aggravated by strenuous work, check with your doctor before operating

#### Proper Clothing



Clothing must be sturdy and snug-fitting, but allow complete freedom of movement. Avoid loosefitting jackets, scarfs, neckties, jewelry, flared or cuffed pants, unconfined long hair or anything that could become entangled with the machine.



Protect your hands with gloves when handling flail and sections. Heavyduty, nonslip gloves improve your grip and protect your hands.



Good footing is most important. Wear sturdy boots with nonslip soles. Steel-toed safety boots are recommended.




To reduce the risk of injury to your eyes never operate a **HD-10P** unless wearing goggles or properly fitted safety glasses with adequate top and side protection.




Tractor noise may damage your hearing. Always wear sound barriers (ear plugs or ear muffers) to protect your hearing. Continual and regular users should have their hearing checked regularly.


## 1.3 Machine safety labels

The safety decals located on your machine contain important information that will help you operate your equipment. Become familiar with the decals and their locations.

	<p><b>DANGER: OBJECTS THROWN BY MACHINE</b> DO NOT OPERATE WITHOUT WEARING SAFETY GLASSES AND A HARD HAT. KEEP UNAUTHORIZED PERSONNEL OUT OF THE GRINDING AREA</p>
---	--


	<p><b>⚠ DANGER</b> <b>OBJECTS THROWN BY MACHINE</b> DO NOT OPERATE WITHOUT WEARING SAFETY GLASSES AND A HARD HAT. KEEP UNAUTHORIZED PERSONNEL OUT OF THE GRINDING AREA!</p>
<p><b>⚠ PELIGRO</b> <b>OBJETOS LANZADOS POR LA MÁQUINA</b> NO OPERE ESTA MÁQUINA SIN LLEVAR PUESTOS LOS ANTEJOS DE SEGURIDAD Y EL CASCO. MANTENGA AL PERSONAL NO AUTORIZADO FUERA DEL ÁREA DE ESMERILADO!</p>	

6500118

	<p><b>DANGER: ROTATING PART HAZARD, STAY OUT OF TUB WHEN ENGINE IS RUNNING.</b></p> <ol style="list-style-type: none"> <li>KEEP OTHERS AWAY.</li> <li>PLACE ALL CONTROLS IN NEUTRAL, STOP ENGINE, REMOVE KEY, AND WAIT FOR ALL MOVING PART TO STOP BEFORE SERVICING, ADJUSTING, REPAIRING, UNPLUGGING, OR ENTERING THE TUB FOR ANY REASON.</li> <li>DISCONNECT DRIVELINE ON PTO MODELS.</li> </ol>
---	--

	<p><b>⚠ DANGER</b> <b>ROTATING PART HAZARD</b> STAY OUT OF TUB WHEN ENGINE IS RUNNING</p> <ol style="list-style-type: none"> <li>KEEP OTHERS AWAY</li> <li>PLACE ALL CONTROLS IN NEUTRAL, STOP ENGINE, REMOVE KEY, AND WAIT FOR ALL MOVING PARTS TO STOP BEFORE SERVICING, ADJUSTING, REPAIRING, UNPLUGGING, OR ENTERING THE TUB FOR ANY REASON.</li> <li>DISCONNECT DRIVELINE ON PTO ORDER MODELS.</li> </ol>	<p><b>⚠ PELIGRO</b> <b>PELIGRO DE PARTE GIRATORIA</b> MANTÉNGASE FUERA DEL TUBO CUANDO EL MOTOR ESTÉ ENCENDIDO</p> <ol style="list-style-type: none"> <li>MANTÉN A LOS OTROS PERSONAS FUERA DEL TUBO</li> <li>ANTES DE SERVICIOS, AJUSTES, REPARACIONES, DESPLUGUE O ENTRAR AL TUBO PARA CUALQUIER MOTIVO, PONER TODOS LOS CONTROLES EN NEUTRAL, DETENER EL MOTOR, QUITAR LA CLAVE Y ESPERAR A QUE TODAS LAS PARTES MOVIENTES SE DETENGAN POR COMPLETO ANTES DE SERVICIOS, AJUSTES, REPARACIONES, DESPLUGUE O ENTRAR AL TUBO PARA CUALQUIER MOTIVO.</li> <li>DESPLUGUE LA LÍNEA DE TRANSMISIÓN EN LOS MODELOS CON TRANSMISIÓN POR EJE.</li> </ol>
---	--	---

6500212

	<p><b>DANGER: ELECTROCUTION HAZARD</b> TO PREVENT SERIOUS INJURY OR DEATH FROM ELECTROCUTION:</p> <p>STAY AWAY FROM POWER LINES WHEN OPERATING BOOM LOADER, FOLDING AND RAISING CONVEYORS, AND TRANSPORTING ON ROADS.</p> <p>THIS MACHINE IS NOT GROUNDED, ELECTROCUTION MAY OCCUR WITHOUT DIRECT CONTACT.</p>
---	--



	<p><b>⚠ DANGER</b> <b>ELECTROCUTION HAZARD</b></p> <p>To prevent serious injury or death from electrocution: Stay away from power lines when operating boom loader, folding and raising conveyors, and transporting on roads. This machine is not grounded, electrocution may occur without direct contact.</p>	<p><b>⚠ PELIGRO</b> <b>PELIGRO DE ELECTROCUCIÓN</b></p> <p>Para evitar lesiones graves o la muerte por electrocución: Manténgase alejado de las líneas de electricidad al operar el cargador con brazo de brazo, las cintas transportadoras de plegado y cables y al transportar. Este equipo no está conectado a tierra y puede producirse la electrocución sin contacto directo.</p>
---	---	--

6500216



**WARNING: FOR YOUR PROTECTION AND SAFETY OF OTHERS, FOLLOW THESE SAFETY RULES**

1. READ AND UNDERSTAND OPERATORS MANUAL BEFORE OPERATING MACHINE.
2. PLACE ALL CONTROLS IN NEUTRAL, STOP ENGINE, REMOVE IGNITION KEY, LOCK OUT POWER SOURCE, AND WAIT FOR ALL MOVEMENT TO STOP BEFORE SERVICING, ADJUSTING, REPAIRING, OR UNPLUGGING.
3. READ AND UNDERSTAND ALL DECALS ON MACHINE FOR YOUR SAFETY.
4. KEEP ALL SHIELDS IN PLACE WHILE MACHINE IS IN OPERATION.
5. KEEP HANDS, FEET, HAIR, AND CLOTHING AWAY FROM MOVING PARTS.
6. KEEP OTHERS AWAY FROM MACHINE WHILE IN OPERATION.
7. INSTALL SAFETY LOCKS BEFORE TRANSPORTING, OR WORKING BENEATH COMPONENTS.
8. DO NOT ALLOW RIDERS AT ANY TIME.
9. DO NOT LEAVE MACHINE UNATTENDED WHILE ENGINE IS RUNNING.
10. KEEP ALL HYDRAULIC LINES, COUPLINGS, AND FITTINGS FREE OF LEAKS DURING OPERATION.
11. KEEP AWAY FROM OVERHEAD ELECTRICAL LINES. ELECTROCUTION CAN OCCUR WITHOUT DIRECT CONTACT.
12. REVIEW SAFETY INSTRUCTIONS PERIODICALLY.

 <b>WARNING</b>	 <b>ADVERTENCIA</b>
<b>FOR YOUR PROTECTION AND SAFETY OF OTHERS, FOLLOW THESE SAFETY RULES.</b>	<b>PARA SU PROTECCIÓN Y LA SEGURIDAD DE OTROS, OBSERVE ESTAS NORMAS DE SEGURIDAD.</b>
<ol style="list-style-type: none"> <li>1. Read and understand operators manual before operating machine.</li> <li>2. Place all controls in neutral, stop engine, remove ignition key, lock out power source, and wait for all motion to stop before servicing, adjusting, repairing, or unplugging.</li> <li>3. Read and understand all decals on machine for your safety.</li> <li>4. Keep all shields in place while machine is in operation.</li> <li>5. Keep hands, feet, hair, and clothing away from moving parts.</li> <li>6. Keep others away from machine while in operation.</li> <li>7. Install safety locks before transporting, or working beneath components.</li> <li>8. Do not allow riders at any time.</li> <li>9. Do not leave machine unattended while engine running.</li> <li>10. Keep all hydraulic lines, couplings, and fittings free of leaks during operation.</li> <li>11. Keep away from overhead electrical lines. Electrocutation can occur without direct contact.</li> <li>12. Review safety instructions periodically.</li> </ol>	<ol style="list-style-type: none"> <li>1. Lea y comprenda el manual del operador antes de operar la máquina.</li> <li>2. Coloque todos los controles en punto neutro, apague el motor, quite la llave de encendido, cierre la alimentación de electricidad y espere a que se detenga todo el movimiento antes de proceder al servicio, ajuste, reparación o desenchufado.</li> <li>3. Lea y comprenda todas las etiquetas adheridas a la máquina para su seguridad.</li> <li>4. Mantenga todas las defensas en su lugar mientras la máquina está en funcionamiento.</li> <li>5. Mantenga las manos, pies, cabello y ropa lejos de las partes en movimiento.</li> <li>6. Mantenga a las personas alejadas de la máquina en funcionamiento.</li> <li>7. Instale los cerrojos de seguridad antes de transportar o trabajar debajo de las componentes.</li> <li>8. No permita que otros monten en la máquina.</li> <li>9. No deje la máquina sin supervisión cuando el motor esté corriendo.</li> <li>10. Mantenga todos los líneas hidráulicas, acoplamiento y conexiones sin fugas durante el funcionamiento.</li> <li>11. Manténgase alejado de las líneas eléctricas elevadas. Puede producirse la electrocución sin contacto directo.</li> <li>12. Revise las instrucciones de seguridad con frecuencia.</li> </ol>

6500208



**WARNING: TO PREVENT SERIOUS INJURY OR DEATH:**

DO NOT WALK UNDER CONVEYOR AT ANY TIME. STAY CLEAR OF CONVEYOR DURING OPERATION, RAISING, AND LOWERING. LOWER CONVEYOR FULLY BEFORE SERVICING.

KEEP OTHERS AWAY.

	 <b>WARNING</b>	 <b>ADVERTENCIA</b>
	<b>OVERHEAD CONVEYOR HAZARD</b>	<b>PELIGRO DE CINTA TRANSPORTADORA ELEVADA</b>
	<p style="font-size: x-small;">To prevent serious injury or death: Do not walk under conveyor at any time. Stay clear of conveyor during operation, raising, and lowering. Lower conveyor fully before servicing. Keep others away.</p>	<p style="font-size: x-small;">No caminar por debajo de la cinta transportadora en ningún momento. Manténgase alejado de la cinta transportadora durante el funcionamiento, al subir y al bajar. Baje completamente la cinta transportadora antes de proceder al servicio. Mantenga alejados a otras personas.</p>

6500214





**WARNING: THROWN OBJECT HAZARD, TO PREVENT SERIOUS INJURY OR DEATH DO NOT RAISE TUB WHEN ROTOR IS TURNING.**

1. DISENGAGE ROTOR AND ALLOW TO COME TO A COMPLETE STOP.
2. BE CERTAIN THAT ALL PERSONNEL ARE CLEAR OF MACHINERY AREA.
3. RAISE TUB TO FULL VERTICAL POSITION.
4. STOP ENGINE AND REMOVE KEY BEFORE APPROACHING TUB AND ROTOR AREA.



6500209



**WARNING: HIGH-PRESSURE FLUID HAZARD, TO PREVENT SERIOUS INJURY OR DEATH:**

- RELIEVE PRESSURE ON SYSTEM BEFORE REPAIRING OR ADJUSTING OR DISCONNECTING.
- WEAR PROPER HAND AND EYE PROTECTION WHEN SEARCHING FOR LEAKS. USE WOOD OR CARDBOARD INSTEAD OF HANDS.
- KEEP ALL COMPONENTS IN GOOD REPAIR.



6500220



**CAUTION: KEEP WHEEL BOLTS TIGHT**



6500042



## 1.4 Shielding

This Industrial Tub Grinder is equipped with heavy-duty shielding at major points of potential injury. All Shields should be kept in place during operation. Bodily injury may occur if the unit is operated without shields.



**WARNING:** Shields are installed for your protection and to keep material off machine parts. Do not operate this Industrial Tub Grinder without shields in place.

## 1.5 Industrial Tub Grinder safety review



**WARNING:** Before attempting to operate your Industrial Tub Grinder, carefully read and follow instructions given below and contained elsewhere in this manual.

Each and every aspect of the **DuraTech HD-10P Industrial Tub Grinder** should be reviewed by each operator on a frequent basis. Safety systems are in place that result in direct operator security.

- Keep all foreign objects including rocks, pieces of metal and other incompressibles out of the tub and away from the mill. Foreign objects may result in personnel injury or damage to the machine. A foreign object is any object which the unit is not designed to grind.
- Allow only responsible, properly instructed individuals to operate machines. Carefully supervise inexperienced operators.
- **Never operate the unit without all safety features, including shields, in place and in operating condition.**
- Make no modifications to this equipment unless specifically requested or recommended by DuraTech Industries.
- Tighten or replace any loose or cracked bolts, chains, hoses or connections.
- Check overhead for electrical power lines or other obstructions and be certain there is adequate clearance.
- Allow no one on the Industrial Tub Grinder at any time during operation.
- Unauthorized personnel should stay out of the grinding area.
- Always perform the pre-operation inspection before operating this machine.
- Ensure rotor is at a complete stop and engine is shut down before any performing any maintenance.



**WARNING:** Loose clothing, necklaces and similar items are easily caught in moving parts. Avoid the use of these items if possible. Keep long hair confined. Keep hands, feet and clothing away from power driven parts.



## 1.6 Thrown objects and operator safety

An operational characteristic of all grinders is that objects may be thrown out of the hopper. Thrown objects may present a safety hazard to persons in the area. This section is to inform the operator of this characteristic, and what can be done to reduce the risk of injury to the operator and persons in the area. Keep all observers away from the machine.

Figure 1.1 shows an object being hit as the hammer is on the upswing. A general pattern for where thrown objects may land is shown in Figure 1.2.

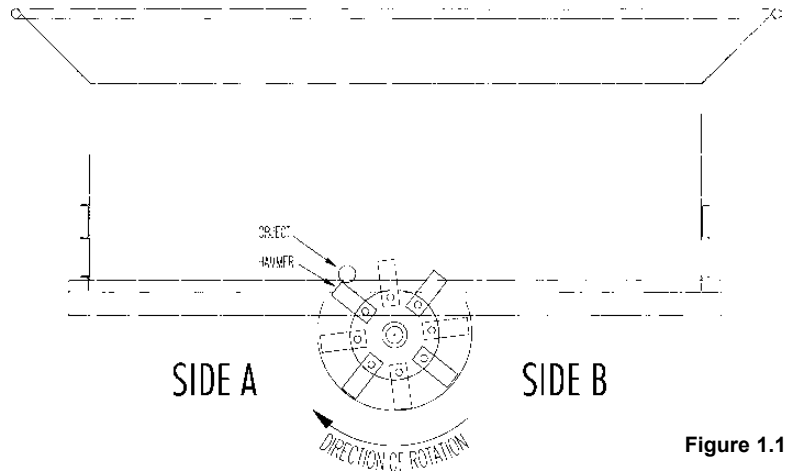


Figure 1.1

Dimensioning the size of this area is not practical. The distance a thrown object may travel is dependent on several conditions, including, but not limited to, rotor speed and diameter, condition of the hammers, style of hammers, object mass, object shape, amount of material in the tub, and how the hammer strikes the object.

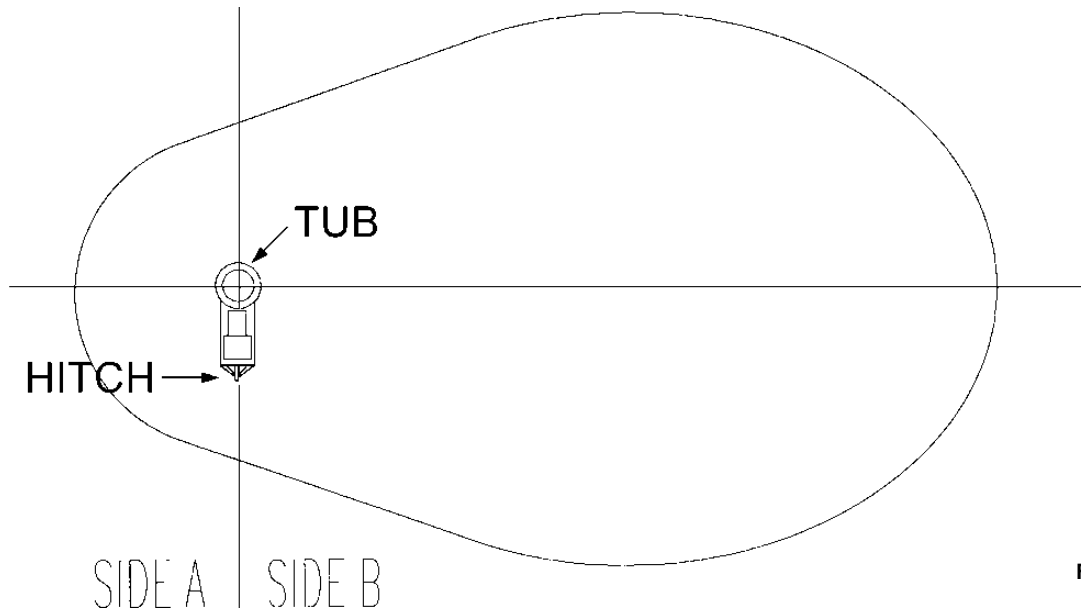


Figure 1.2



**NOTE:** The difference in the size of the area for side A versus side B. Side B is larger.



The amount of material in the tub can dampen or stop the object's potential flight. Keeping the tub full will reduce the risks. Filling the tub at least 1/2 full when starting will reduce the risk. Using a geyser plate can help reduce thrown objects. A risk may arise when the tub is being emptied, such as at the end of the grind. Running the engine at slower speeds when starting or finishing the grind will also help, especially slowing down when emptying the tub. Keeping the tub covered with DuraTech Tub Covers will also reduce the risk of potential injury or property damage. Use of a Tub Cover will not reduce the area over which thrown objects may fall, but it does reduce the percentage of objects thrown from the tub.



**WARNING:** To minimize the potential risk of injury or property damage, the operator must:

- a) Place side B towards open areas, away from property and people.
- b) Load the grinder from side A with a loader equipped with an enclosed cab.
- c) Keep observers out of the area.
- d) Wear a hard hat and safety glasses, at a minimum, and require that any other persons in the area are similarly equipped.
- e) If the optional tub cover is installed on the machine, the operator should keep the Tub Cover over the tub as much as possible while grinding. While grinding, the Tub Cover should be raised only when adding material to the tub, and then the Tub Cover should only be raised enough to allow the new materials to be placed in the tub.

## 1.7 Service and maintenance



**CAUTION:** The stored up energy in the rotor causes it to rotate long after the engine rotor clutch has been disengaged. Before performing any maintenance on the machine or getting into the tub, be sure rotor and all moving parts have come to a complete stop. Shut off engine and remove the key.

Before working on or near the Industrial Tub Grinder for any reason such as servicing, inspecting or unclogging the machine:

- Follow the normal shutdown procedure found on page 24 of this manual.
- If the unit is still attached to a towing vehicle, place the towing vehicle's transmission in park and set the parking/emergency brake.



- Relieve all pressure in the hydraulic system before disconnecting hydraulic lines or performing work on the system. Make sure all connections are tight and the hoses and lines are in good condition before applying pressure to the system.



**WARNING:** Hydraulic fluid escaping under pressure can be invisible and have enough force to penetrate the skin. When searching for a suspected leak, use a piece of wood or a cardboard rather than your hands. If injured, seek medical attention immediately to prevent serious infection or reaction.

When replacing any part on your Industrial Tub Grinder, be sure to use only DuraTech authorized parts.

## 1.8 Personal protection equipment

Operators and authorized observers of the Industrial Tub Grinder are required to wear head, eye, and ear protection. No loose clothing is allowed.

## 1.9 Fire Prevention

Grinding wood, hay, and other products in a tub grinder produces a large amount of potentially combustible material. The risks of fire can be significantly reduced with proper operating and maintenance procedures. This does include frequent removal of dust, debris, and other combustible materials.

Most of the products that are ground are dry and the grinding process can produce fine, dusty material. The grinding process can produce heat and the spinning rotor will circulate air within the grinding chamber. For a fire to start, fuel, oxygen and heat in sufficient quantity, must be present. During normal operation and with a properly maintained tub grinder, the material being ground will move through the grinding chamber so quickly that it doesn't have a chance to heat up sufficiently to start a fire. Also, the rapid rate that a tub grinder can pile material will quickly smother small hot spots that might occur during normal grinding operations. Keeping the material moving through the machine and across the top of the rotor is important to keep frictional heating of the material to a minimum.



**NEVER** leave the vicinity of the unit with the engine running.

### PROPER OPERATION OF THE TUB GRINDER:

- Do not grind materials any finer than necessary. Finely ground materials will produce more dust and increase the risk of fire. If finely ground materials are required, it is better to grind the materials coarse first with large opening screens installed in the grinder and then regrind them to the desired consistency by installing smaller opening screens in the grinder. Be especially cautious when grinding materials that can burn easily.



- When filling the tub grinder during start-up begin by filling the rear of the tub and avoid placing materials on the spinning rotor. When material begins to fall over the rotor, set the governor control on “Manual” and rotate the tub slowly while continuing to fill the tub. Use the tub cover to control thrown objects as much as possible. When the tub is 1/2 to 2/3 full, the governor control can be set to “auto” and grinding operations can resume normally. Do not allow the tub to stop for any significant amount of time with material over the rotor to minimize frictional heating.
- Do not smoke when working with combustible materials.

#### REMOVAL AND CLEANING INSTRUCTIONS:

- Clean the engine compartment daily or more often if conditions require it be done more frequently. When cleaning the engine compartment, always clean the top of the engine and the areas around exhaust manifolds, exhaust plumbing and turbochargers.
- Check the rotor box for debris built up around the rotor. Remove material that may be packed tight near the bearings, on shaft or other rotating components because it will become hot due to friction.
- At shutdown, always clean and remove all dust, debris, or combustible material off the entire grinder. Use high-pressure air or water if necessary. Always move the grinder and all other equipment away from the ground material pile before leaving the job site in case of smoldering combustion in the ground material.

#### TUB GRINDER MAINTENANCE:

- Repair any fuel or hydraulic leaks as quickly as they are discovered. Clean up spills immediately. Fuel or oil soaked materials can contribute significantly to the rapid spreading of a fire once it has begun.
- Inspect all electrical wiring periodically. Any chafed or damaged wires should be repaired immediately. Keep all electrical connections tight to prevent arcs or sparks.
- Contact between the rotor and any stationary component of the grinding chamber such as contact between the hammers and the screens must be corrected immediately.

## 1.10 Fire extinguishers

Fire extinguishers are provided on all DuraTech Industries grinders in the unlikely event that a fire does start on the grinder. An extinguisher is located on both sides of the machine near the front of the engine compartment. The extinguishers are ABC dry chemical extinguishers that are appropriate for use with all materials normally encountered on a tub grinder.

If a fire does start, CALL THE LOCAL FIRE DEPARTMENT IMMEDIATELY. Then, use the fire extinguisher if you feel confident that you can extinguish the fire. A 10# extinguisher will last about 15-20 seconds and a 20# extinguisher will last about 20-24 seconds, so they will not stop a large fire.



**When using a fire extinguisher, use the P A S S method:**

- Approach the fire with the wind at your back.
- **Pull the pin,**
- **Aim the spout,**
- **Squeeze the trigger, and**
- **Sweep along the base of the fire from about 6-8 feet away.**

Read the label on your extinguisher now, most extinguishers have descriptions of this method, and an estimated working time.

If an extinguisher is only partially used, the dry chemical will jam in the seals, allowing the extinguisher to lose its pressure charge in less than an hour, making it useless to you. It must be recharged before placing it back on the machine. Have the extinguisher recharged today; a fire will not wait for you to recharge your extinguisher tomorrow!

Fire extinguishers should be inspected and recharged by a professional at least annually to keep them at optimum performance! A “verification of service” collar that confirms the month and year of service should be attached to the neck of the container to confirm when the extinguisher was last serviced.

## **1.11 Important safety reminders**

Always follow basic safety precautions when using this unit to reduce the risk of injury.



**IMPORTANT: NEVER** perform maintenance in the tub, under the machine, on the conveyor, or other moving part of the machine without first shutting off the engine and removing the key.

Unauthorized personnel should stay out of the grinding area. Flying debris can injure inattentive personnel.



**IMPORTANT: NEVER** climb on the machine, crawl under the machine, or enter the tub when the engine is running or the machine is in operation.

## **1.12 Towing**

Check all lights, brakes and hitch connections before towing. Check your state laws regarding the use of lights, safety chains, moving wide loads on public roads, and other possible requirements.

Use caution when traveling on public roads, rough or winding roads, or steep terrain.

See Section 4.22 for more information about preparing the unit for transport.







## Section 2: Introduction

### 2.1 Description of the DuraTech Industrial Tub Grinder

The Industrial Tub Grinder is designed to grind wood waste, green waste, construction and demolition debris, tree branches and trunks, compostables and mulch. The unit incorporates a number of basic features including the rotating tub, the electronic governor, the rotor and hammer assemblies, the tub chain and drive assemblies, the clutch and torque limiter assemblies, belly and discharge conveyors, and the axle and hitch assemblies.

Material is fed into the tub of the unit by appropriate means, such as a wheel loader. As the tub rotates, the material is exposed to the rotating hammers. The hammers then grind up the material before the material is discharged by the belly and discharge conveyors.

figure 2.1  
side view showing  
operator's station with  
discharge conveyor and  
operator's protection  
screen in the transport  
position

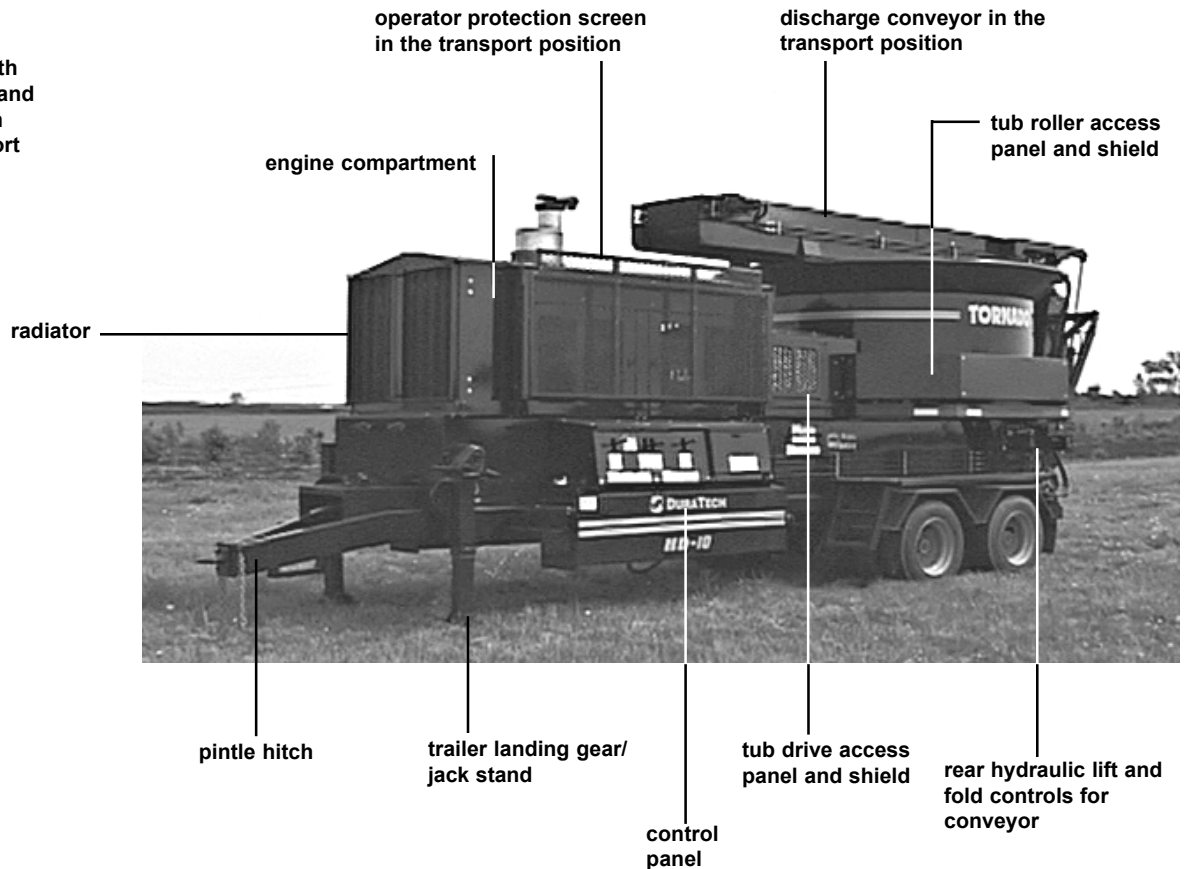
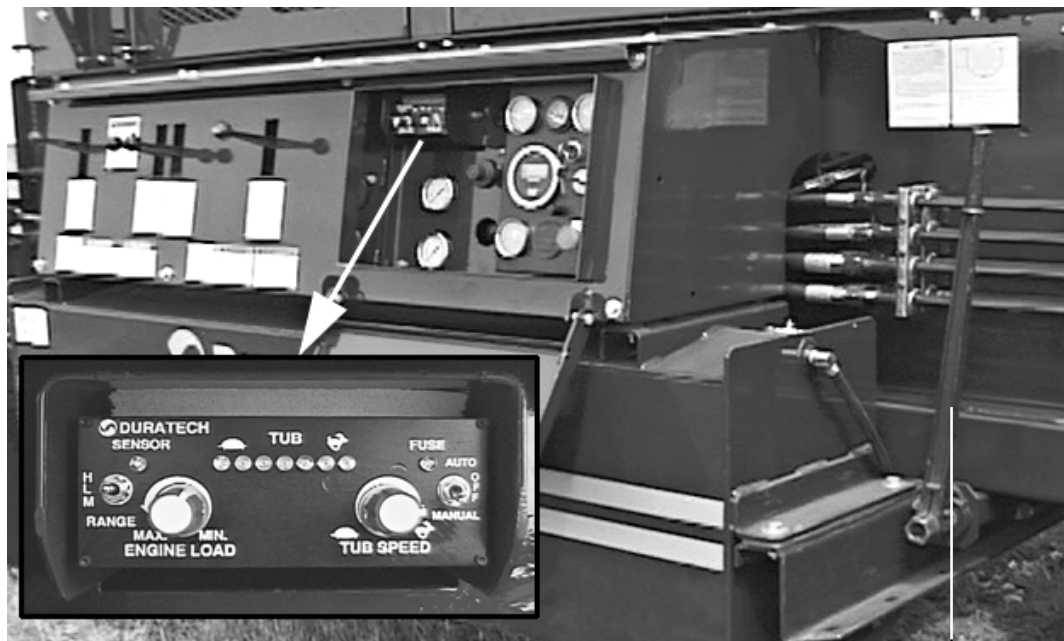




figure 2.2  
position of the electronic  
governor on the control  
panel



rotor clutch lever

## 2.2 Electronic governor

The Model Electronic Governor regulates the speed at which the tub rotates. The electronic governor has two modes of operation, the Engine (Auto) mode and the Tub (Manual) mode. The Engine (Auto) mode is the preferred mode of operation and should be used whenever possible.



**IMPORTANT:** Except when calibrating or trouble shooting the electronic governor always use the Engine (Auto) mode of the electronic governor.

### Engine (Auto) Mode

When the electronic governor is switched to the Engine (Auto) mode, it is monitoring the rotation speed of the engine. The hydraulic flow to the tub drive mechanism is regulated proportionally to the engine speed. When the engine begins to lug down, the hydraulic oil flow is reduced which in turn slows down the tub rotation. With proper calibration, the engine will only lug down to its optimum horsepower RPM and the tub rotation will be varied proportionally to keep the engine at this RPM. The result is a nearly constant load on the engine, which will maximize grinding efficiency. See section 3.11 (pg. 31) for calibration instructions.

### Tub (Manual) Mode

In this mode the tub speed is constant and it will not change to match varying load conditions.



## 2.3 Rotor clutch

The clutch engages and disengages the rotor shaft. Engagement and disengagement of the clutch is accomplished through the use of a manually operated lever that is located on the left hand side of the engine.

## 2.4 Friction disc torque limiter

The friction disc torque limiter is installed to prevent or reduce damage to the engine and clutch in the event of an instantaneous stop due to a rotor overload.

## 2.5 Rotor

The rotor is the heart of the grinder. The standard rotor contains swinging hammers and is used for general grinding. When larger objects such as tree trunks are to be ground, fixed hammers are used.

## 2.6 Screens

The DuraTech HD-10P industrial tub grinders come equipped from the factory with two screens. The factory equipped screens are a 3" diameter hole screen and a 4" diameter hole screen. These screens are installed in combination with the 3" diameter hole screen placed on the left hand side of the rotor box.

Any combination of hole sizes may be used to alter the size of the outputted material. The size of the ground material is determined by the diameter of the screen holes. As the diameter of the screen holes becomes larger, the size of the ground material increases.

Round perforated screens are available with 2", 3", 4" and 5" diameter holes in thick steel. A 6" x 7" demolition screen is also available. The demolition screen is used for size reduction on construction debris, demolition debris and wet materials.



**NOTE:** If a combination of screens with different hole diameters are used, the screen with the smallest hole diameter is normally placed on the left hand side of the rotor box.

## 2.7 Tub

Material to be ground is loaded into the tub using a wheel loader, or other suitable methods. As the tub rotates, the material is fed into the rotor. The faster the tub rotates, the more material is exposed to the rotor, and the greater the load on the engine. The tub's rotation speed is controlled by the electronic governor. To reduce the amount of material thrown from the tub during operation, the tub should be kept 1/2 to completely full.

The HD-10P's tub can be tilted 90 degrees for access to the rotor, screens, and drive line. The tub has an electronic safety switch that will not allow the tub to be raised with the rotor turning. The switch provides feedback to the operator through two indicator lights which are located on the control panel. If the green indicator light is on, the operator may tilt the tub. Conversely, if the red indicator light is on, the safety switch will prevent the operator from tilting the tub.



## 2.8 The conveyor system

The conveyor system on the HD-10P consists of a belly conveyor and a discharge conveyor. The belly conveyor transfers the ground material from the rotor to the discharge conveyor. The discharge conveyor then moves the material away from the unit. The conveyors are run by two hydraulic orbit motors which are turned on and off with one control lever. This control lever is located at the control panel on the left side of the engine. The discharge conveyor can be raised or lowered from the control panel or from the conveyor controls located at the left rear of the machine. The discharge conveyor can also be folded for transport from the conveyor controls located at the left rear of the machine.

## 2.9 Magnetic roller (optional)

An optional roller can be added to the unit which removes nails and other iron products from the ground material.

## 2.10 Mill grate (optional)

An optional grate can be installed above the rotor to regulate the amount of material entering the rotor chamber. The mill grate can be used for general grinding. The hammer spacing in the rotor must require change for this option.

## 2.11 Hydraulic cooler

The hydraulic system dissipates excess heat by constantly flowing through a radiator.

## 2.12 Tub cover (optional)

An optional tub cover may be added to the unit that helps to reduce the amount of material ejected from the tub while grinding.



Tub cover in raised position



## 2.13 Overview of the HD-10P operator controls

figure 2.3  
HD-10P control panel

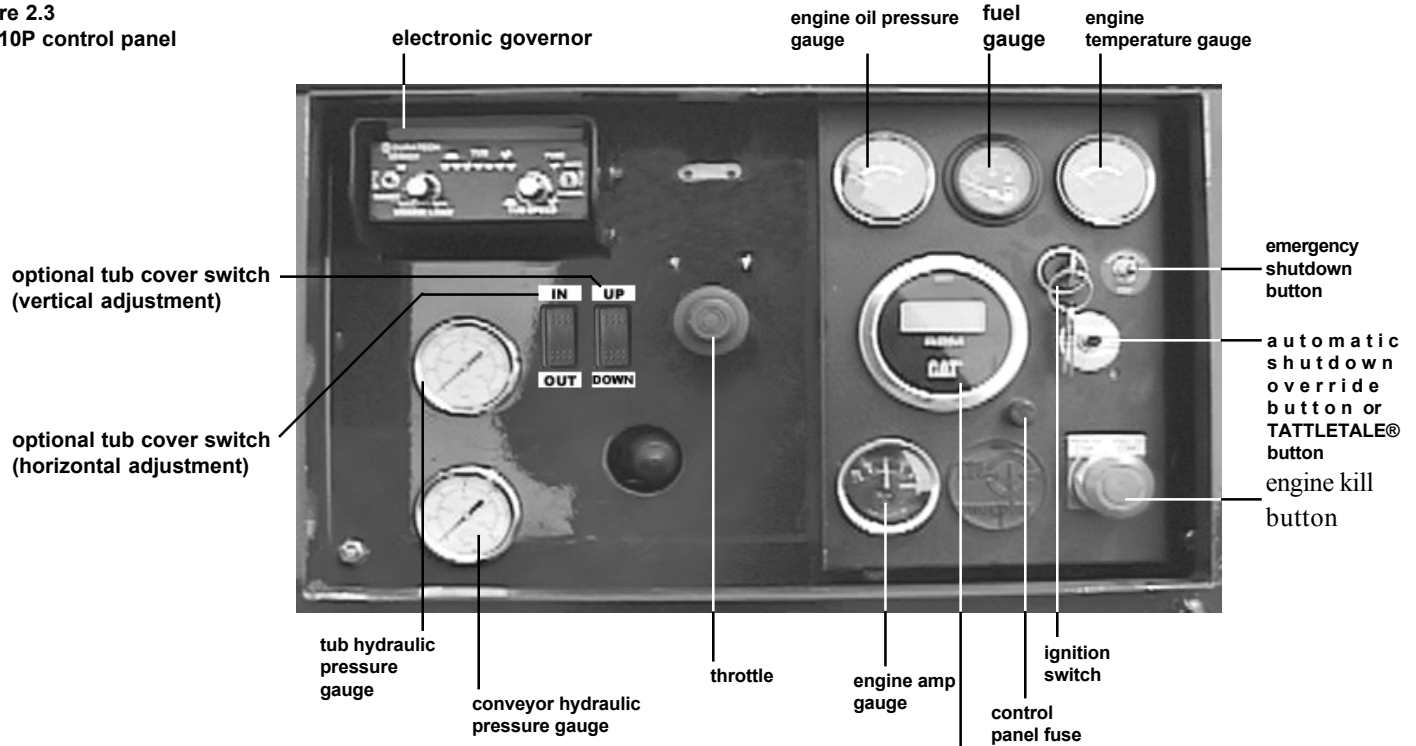


figure 2.4  
control panel levers



### 2.13.1 Control Panel

The control panel is located on the left hand side of the engine. Controls on the control panel include; engine starter, engine kill button, throttle, tub controls, conveyor on/off lever, conveyor height adjustment lever, automatic shutdown override button (TATTLETALE® button) and the tub tilt lever.



## 2.13.2 Other operator controls

### Tub lock latch

The tub lock latch is located on the left hand side of the machine just to the rear of the engine shroud. The tub lock latch is released automatically when the tub is raised.

### Rear conveyor controls

The rear conveyor controls are located at the rear left corner of the machine. The operator can use one lever to fold and unfold the conveyor from the conveyors transport position. A second lever allows the operator to raise or lower the discharge conveyor.

### Clutch lever

The clutch lever is normally placed near the operator station control panel shown in figure 2.3. This lever allows the operator to engage or disengage the rotor.

### Radio remote control unit (optional)

The optional four function radio remote control unit allows the operator to remotely start and stop the tub, change the tub's direction of rotation to forward or reverse and perform an emergency stop.

The optional six function radio remote control unit also allows the operator to raise and lower the discharge conveyor.



**NOTE:** See also section 3.17, "Operating the grinder using the remote radio option."

### Tub cover controls (optional)

The controls for the Tub Cover are located on the main control panel of your Industrial Tub Grinder. If you have a remote control for your grinder, Tub Cover controls may also be installed on the remote control unit. Controls consist of a tub cover up/down rocker switch, and a tub cover in/out rocker switch.

The switch marked Tub Cover Up/Down (vertical adjustment) raises and lowers the tub cover, and the switch marked Tub Cover In/Out (horizontal adjustment) moves the main frame toward or away from the tub. The Tub Cover functions can also be activated by the optional remote radio. During normal grinding, keep the tub cover as close to the tub as practical for more coverage.



## Section 3: Operation

### 3.1 Pre-operation inspection

Read and have a thorough understanding of the operator's manual, especially the sections pertaining to machine operation and safety. Also make sure that anyone who will assist you in the operation or maintenance of this machine understands how the machine operates.

Before operating the HD-10P Industrial Tub Grinder, perform an inspection that includes the following items. As each task is performed, check or initial the adjacent box.

- Check lubrication points and lubricate as recommended in the general maintenance section of this manual.
- Make sure that the machine is properly adjusted. Procedures for making adjustments to various HD-10P components can be found later in this section.
- Check engines oil level and coolant level, and add or change as necessary. Also look for oil or coolant leaks and repair as necessary.
- Check the hydraulic oil level, and add or change the hydraulic oil as necessary. Also check the hydraulic system for leaks.



**WARNING:** Hydraulic fluid escaping under pressure can be invisible and have enough force to penetrate the skin. When searching for a suspected leak, use a piece of wood or a cardboard rather than your hands. If injured, seek medical attention immediately to prevent serious infection or reaction.

- Check the air cleaner service indicator. If the red indicator is visible, service the air cleaner.
- Check for buildup of debris around the radiator, turbocharger, manifolds, air intake moving parts and on top of the engine. Remove the debris before operating the unit. Buildup of excess debris may result in fire.
- Inspect belts for cracks, breaks, or other damage.
- Inspect wiring for loose connections and for worn or frayed wires.
- Check the fuel supply, and drain any water from the water separator.
- Visually examine the rotor to see if any parts show excessive wear. These parts include shaft, plates, rods, hammers and movable plate. Replace or repair any worn parts before operating the unit.
- Check the screens for wear. Also check the screen hold downs for wear and tightness. Replace or repair any worn parts before operating the unit.
- Visually examine the rotor bearings and the mounting bolts and check all bearings for wear. Replace or repair any worn parts before operating the unit.
- Make sure that all shields and guards are in place and in operating condition.
- Check clutch adjustment.



## 3.2 Starting the Industrial Tub Grinder



**NOTE:** The engine will start easier at cool temperatures by use of a starting aid. A block heater or other means can be used to warm the engine.

**NOTE:** Do not crank the engine for more than 30 seconds. Allow the starter motor to cool for two minutes before cranking again

Check engine manufacturers recommendations before starting the engine, and follow their recommendations where applicable.

Check for **DO NOT OPERATE** or similar warning tags. Do not move any controls if such tags are on the machine.

To start the engine, perform the following steps:

1. Perform the pre-operation inspection.
2. Disengage the clutch lever.
3. Set the throttle to approximately half engine speed.
4. Shout the word **“CLEAR”**.
5. Press and hold down the TATTLETALE® button.
6. Turn the key to the start position and release it when the engine starts.
7. Release the TATTLETALE® button 10 seconds after the engine starts. If the oil pressure does not rise within ten seconds after starting, stop the engine and make the necessary repairs.
8. Reduce the engine speed to a low idle. Allow the engine to idle for 3 to 5 minutes, or until the water temperature gauge indicator has begun to rise. The engine should run smoothly at low idle.
9. Make another walk-around inspection checking the engine and hydraulic system for fluid leaks.
10. Follow the engine manufacturers recommendations for the care and maintenance of a new engine.



**NOTE:** See also section 3.17, “Operating the grinder using the remote radio option”





### **3.3 If the engine fails to start**

If the engine doesn't start on the first try, perform the following steps:

1. Wait two minutes before attempting to restart.
2. Shout the word “**CLEAR**”.
3. Depress and hold the TATTLETALE® button and turn the key clockwise to crank the engine. Do not crank for more than 30 seconds.
4. If the engine fails to start contact a qualified diesel mechanic for further advice.

### **3.4 Throttle operation**

To increase throttle speed slowly, turn the throttle knob counter clockwise rather than pulling the knob straight out.

To decrease throttle speed, turn the knob clockwise.

For emergency slowdown, depress and hold the lock button in the center of the throttle knob and push the throttle knob straight in.

### **3.5 Automatic engine shutdown system**

The engine will automatically shut down if it overheats or if engine oil pressure is inadequate. If this happens, perform the following steps:

1. Check the engine oil level.
2. Inspect the radiator and clean if necessary.
3. Check tension and condition of the fan belt.
4. Allow engine to cool and check the coolant level.
5. Attempt to restart engine following the normal starting procedure.
6. If the engine will not continue running, contact a qualified mechanic.



## 3.6 Normal shutdown procedure



**NOTE:** Stopping the engine immediately after it has been working under load can result in overheating and accelerated wear of the engine components. Allow the engine to cool down before stopping. Avoiding hot engine shutdowns will maximize turbocharger, shaft, and bearing life.

Use the following procedure to shut down the Industrial Tub Grinder under normal operation:

1. Disengage the tub drive.
2. Allow the tub conveyor belts to run until empty.
3. Disengage the rotor clutch.
4. Disengage the conveyor drive.
5. Follow the engine manufacturer's recommendations for cooling the engine; generally, this consists of running the engine at 1/2 speed or idle for 5 minutes.
6. Shut off the engine and remove the key.
7. Note the service hour meter reading, and perform periodic maintenance as required.
8. Repair any leaks, perform minor adjustments, tighten loose bolts, etc.

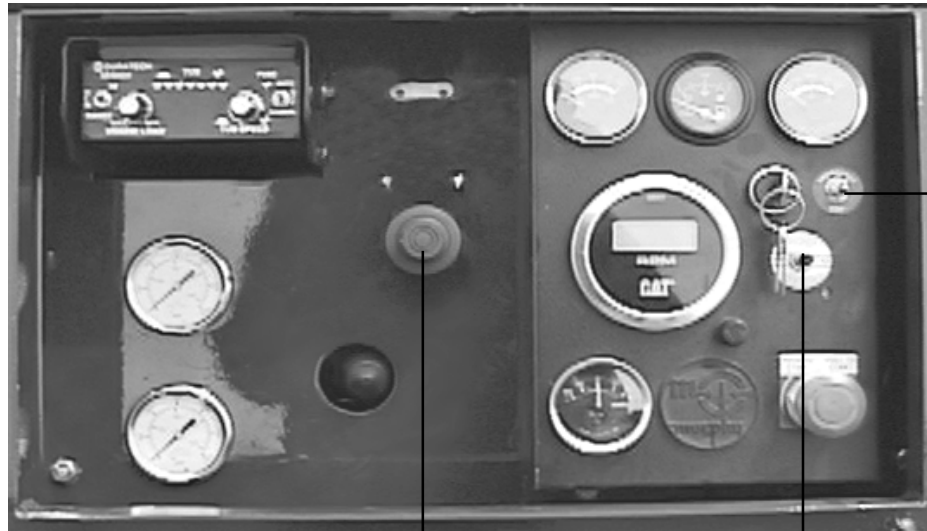


**NOTE:** See also section 3.17, "Operating the grinder using the remote radio option"



### 3.7 Emergency shutdown procedure

figure 3.1  
emergency shutdown  
button and emergency  
stop button



engine kill button  
NOTE: pull this button  
out to reset.

TATTLETALE® button  
NOTE: push and hold down this button to  
start.

emergency  
shutdown  
button  
NOTE: push  
and hold  
down until  
engine  
stops.



**IMPORTANT:** Emergency shutoff controls are for **EMERGENCY** use Only. **DO NOT** use the emergency shutoff controls for normal stopping procedure.

1. Push in the engine kill button or the emergency shutdown button located on the control panel and remove key.



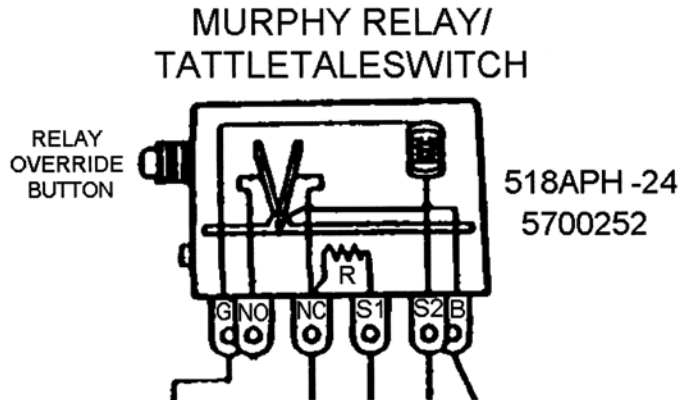
**NOTE:** The engine kill button will have to be reset before restarting the engine.

**NOTE:** See also section 3.17, “Operating the grinder using the remote radio option”



### 3.8 Murphy System Operation

There are 5 terminals on the bottom of the 518PH Murphy relay. There are 6 terminals on the bottom of the 518APH Murphy relay. Both types are used on Caterpillar engines equipped with remote mounted Murphy panels. 24VDC power is supplied from the key switch from the IGN terminal when the key is in the run position. The power passes through a panel-mounted fuse and enters the Murphy relay at terminal [B]. When the override button is depressed, power is available at the [NC] terminal and at the [SW1] terminal. There is a resistor (400-ohm) between [NC] and [SW1]. Power returns to the relay through terminal [SW2] (Approx. 10 VDC is measured by a voltmeter at [SW2] when the relay is installed in the grinders), which keeps the relay latched electrically (Closed Loop circuit). The fifth terminal is the ground [G] terminal. The sixth terminal found only on the 518APH is the [NO] terminal which will be energized when the Murphy relay is unlatched and the key switch is in the run position. The sixth terminal [NO] is not used on the DuraTech tub grinders.



On the Caterpillar engines, power must be supplied to the fuel supply valve in order for the engine to run. The fuel supply valve is connected to the [NC] terminal of the Murphy relay so, power is only supplied to the fuel valve when the Murphy relay button is pushed in and the key switch is in the run position. The oil pressure SWITCHGAGE, the water temperature SWITCHGAGE, the tub tilt interlock system, and all emergency stop buttons are connected to the Closed Loop circuit which is connected from [SW1] to [SW2] on the Murphy relay. Any of the above controls can shut the engine down by connecting the Closed Loop circuit to “ground” (usually a local frame ground). This will “short circuit” the power that is emitted from [SW1] directly to ground and no power will return to [SW2]. This will cause the Murphy relay to unlatch and power will be shut off to the fuel supply valve, causing the engine to shutdown. The 400-ohm resistor in the Murphy relay reduces the voltage to approximately 10 VDC so arcing is minimized when a shutdown signal is activated. Also, any “inadvertent ground” in any wire of the Closed Loop or loss of power in the Closed Loop will cause the Murphy Relay to unlatch and the engine will shut down.



## **3.9 Parts of the electronic governor**

### **FUSE LIGHT**

This light is on whenever the electronic governor is receiving power.

### **SENSOR LIGHT**

This light is on whenever the electronic governor is receiving an adequate input signal from the sensor. For the sensor light to work you must:

- Have the clutch engaged.
- The engine running at grinding RPM.
- The Mode Switch must be switched to the engine position.

### **SPEED LIGHTS**

These lights provide a relative indication of how fast your tub should be turning based on the output signal that the electronic governor is sending to the electro-hydraulic valve.

### **MODE SWITCH**

The mode switch has three possible positions.

The off position which turns the electronic governor off and two other positions which correspond to the tub (manual) and engine (auto) modes of operation.

In the “tub (manual)” position the tub will rotate at a constant speed based on the settings of the Tub Limit Knob (Tub Speed Knob).

The “engine (auto)” position uses all the functions of the Electronic Governor. The maximum tub speed will be limited by the Tub Limit Knob (Tub Speed Knob), and the engine load will be controlled by the Engine Load Knob.

### **TUB LIMIT KNOB (TUB SPEED KNOB)**

This knob sets the maximum speed at which the tub will rotate in both the tub (manual) and engine (auto) modes. In the engine (auto) mode tub speed will vary between zero and this setting depending on the engine load.

### **ENGINE LOAD KNOB**

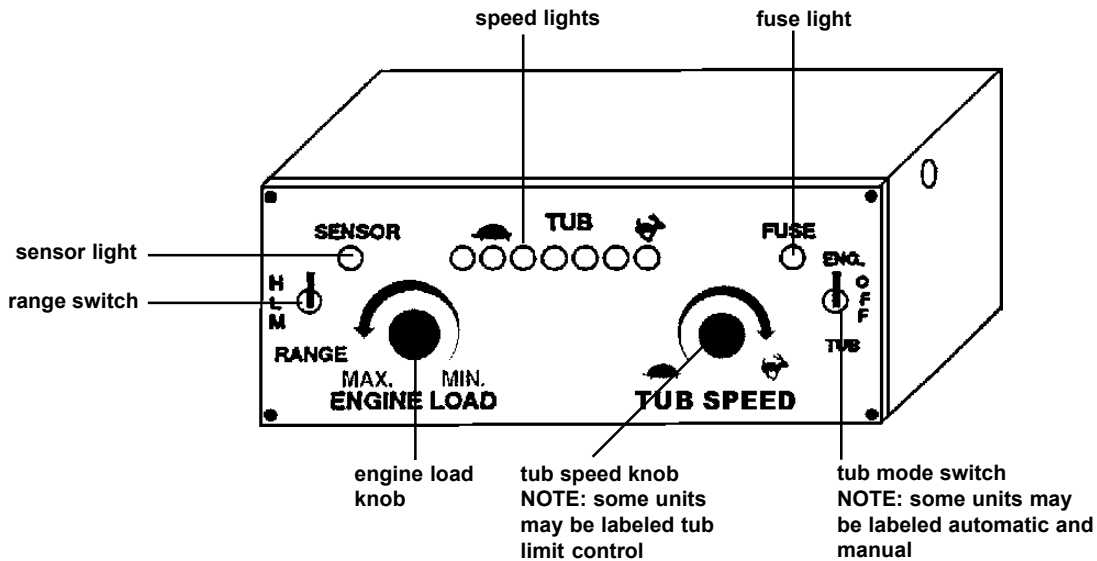
This knob is used only in engine (auto) mode. It controls the load placed on the engine. Turning the knob clockwise decreases engine load, and turning the knob counterclockwise increases the engine load.

### **RANGE SWITCH**

This switch is a coarse adjustment for the engine load knob and can be switched to a H- high, M-medium or L-low setting.



figure 3.2  
electronic governor  
controls



### 3.10 Operation of the electronic governor

#### Engine (Auto) mode



**IMPORTANT:** Except when calibrating or troubleshooting the electronic governor always use the engine (auto) mode of the electronic governor.

In engine (auto) mode, the electronic governor monitors the rotation speed of the engine. The hydraulic flow to the tub drive mechanism is regulated in proportion to the engine speed. As the engine speed slows, the electronic governor decreases the hydraulic flow which slows down the tub's rotation. Conversely, as the engine speed increases, the electronic governor increases the hydraulic flow which speeds up the tub's rotation. This allows the electronic governor to automatically control the feed rate keeping the engine running within the governor's optimum power zone. When the load on the grinding rotor begins to lug the engine, the governor automatically reduces the tub's rotation speed in proportion to the load. The result is nearly a constant load on the engine, which maximizes the grinding efficiency.

The range of rotor speeds for which the electronic governor will regulate the hydraulic flow is determined by the setting of the engine load knob. For example, turning the engine load knob counter clockwise will increase the load on the engine by keeping the tub engaged to a lower engine RPM.

With proper calibration, the engine will only load down to its optimum horsepower RPM, and the tub's rotation speed will be varied proportionally to keep the engine at this RPM.

#### Tub (Manual) mode

In tub (manual) mode, the electronic governor performs as a simple tub speed control. In this mode the tub speed is constant and it will not change to match varying load conditions.



### 3.11 Calibration of the electronic governor

To calibrate the electronic governor, perform the following steps:

1. Begin calibration procedure with HD-10P Tub Grinder completely shutdown. Place the MODE switch in the OFF position and the RANGE switch in the H-High position. Rotate the TUB SPEED KNOB fully clockwise toward the rabbit position. Turn the ENGINE LOAD KNOB fully clockwise, and switch the MODE switch to ENGINE (Auto) Position.
2. Verify that rotor clutch is disengaged. Inspect machine to verify that all personnel are clear of the machine.
3. Start engine and run the grinder at about 1/2 throttle to allow the hydraulic system to warm up before calibrating the Electronic Governor.
4. When the system has reached operating temperature, throttle the engine to below 1000 RPM. Engage the tub drive and throttle up to 1800 RPM. The FUSE light and the SENSOR light should come on. The tub should not be rotating at this time. If the tub is rotating, read section 6.1 “Troubleshooting the electronic governor system” in this manual.
5. Slowly rotate the ENGINE LOAD KNOB counter-clockwise until the tub just begins to move. The tub should begin to rotate. If it does not begin to rotate, switch the range switch to M-Medium or L-Low and repeat as necessary.

**TEST:** Throttle the engine down and the tub should stop rotating, return the engine to 1800 RPM and the tub should start to rotate.

If the tub will not rotate, read section 6.1 “Troubleshooting the electronic governor system” in this manual.

### 3.12 Adjusting the tub's rotation speed

Tub rotation is controlled by two components . The tub is started, stopped and reversed by the tub forward/reverse control lever on the control panel, and the tub's rotation speed is controlled by the tub limit knob (tub speed knob) on the electronic governor.



tub forward/reverse control lever



### 3.13 Raising the tub



**NOTE:** If the grinder becomes plugged or if the rotor requires maintenance, do not raise the platform with the tub full of material.

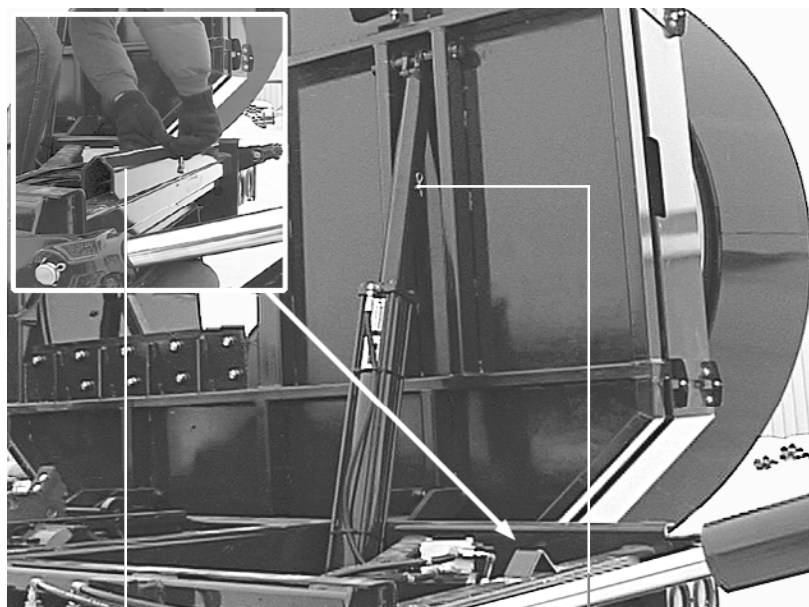
To raise the tub, perform the following steps:

1. Verify that the tub grinder is parked on level surface.
2. Disengage the clutch, and wait for the rotor to stop turning.
3. If your HD-10P is equipped with a tub cover, then place tub cover in the fully closed position.
4. As material in the tub may roll some distance, make sure the area on the right hand side of machine is clear of personnel and equipment. Shout the word “**CLEAR**”.
5. The engine speed should be 1000 RPM.
6. Operate the tub tilt lever on the control panel to raise the tub. If the red tub interlock indicator on the operator station control panel is lit, the tub will not raise. If the green tub interlock indicator on the operator station control panel is lit, the tub may be raised.
7. Raise the tub fully, and install the safety stop on the hydraulic cylinder. The safety stop is located in its storage location on the belly conveyor cover.



**NOTE:** The tub will not lift if the rotor is turning. Also, if the tub is raised and the clutch is engaged, the engine will be shut off. *Never engage clutch when tub is raised.* The hydraulic cylinder will not raise the tub if the tub is full of material.

**figure 3.3**  
tub cylinder safety stop  
working and storage  
locations



tub cylinder stop storage location

tub cylinder stop with lock pin installed





### 3.14 Lowering the tub

To lower the tub, perform the following steps:

1. Clear the area of equipment and personnel.
2. Engine speed should be 1000 RPM.
3. Remove the safety stop on the hydraulic cylinder, and place safety stop in storage location on the belly conveyor cover.
4. Operate the tub tilt lever on the control panel to lower the tub.
5. The tub lock latch should engage automatically when the tub platform is lowered fully. Verify that the latch lock is engaged before continuing.

### 3.15 Starting and stopping the belly and discharge conveyors

The belly and discharge conveyors are on one circuit, so one control starts and stops both conveyors. The control is found at the operator panel near the engine. Conveyors must be started before the rotor and must be allowed to run after the rotor is shut off.



**NOTE:** See also section 3.17, “Operating the grinder using the remote radio option”

### 3.16 Lifting the discharge conveyor

The discharge conveyor can be raised or lowered as needed. There are two sets of controls for raising and lowering the conveyor. One set of controls is at the operator panel and one set is at the rear left of the machine.



**NOTE:** See also section 3.17, “Operating the grinder using the remote radio option”





## **3.17 Operating the grinder using the remote radio option**

### **Using the Microtronics remote radio controller**

Switch located on the control panel will switch from manual to remote control. Switch to remote when remote control is desired.

The remote will stop the engine, raise and lower the conveyor (if so equipped), and start, stop and reverse the tub. If your machine is equipped with a tub cover, the remote can also raise and lower the tub cover.

To stop the engine, push and hold the button until the engine stops. Starting the engine must be done at the control panel.

To change the conveyor height, push and hold the correct button (raise or lower) until the conveyor is at the desired height. Release the button.

To change tub cover height, push and hold the correct button (Opt1 or Opt2) until the tub cover is at the desired height. Release the button.

To change tub direction:

- If the tub is rotating forward, pushing the reverse button once will stop the tub. Pushing the reverse button the second time will reverse the tub. There is a two second delay when changing tub direction.
- If the tub is rotating in reverse, pushing the forward button once will stop the tub. Pushing the forward button the second time will start the tub rotating in the forward direction.



## Using the Omnex Origa remote radio transmitter

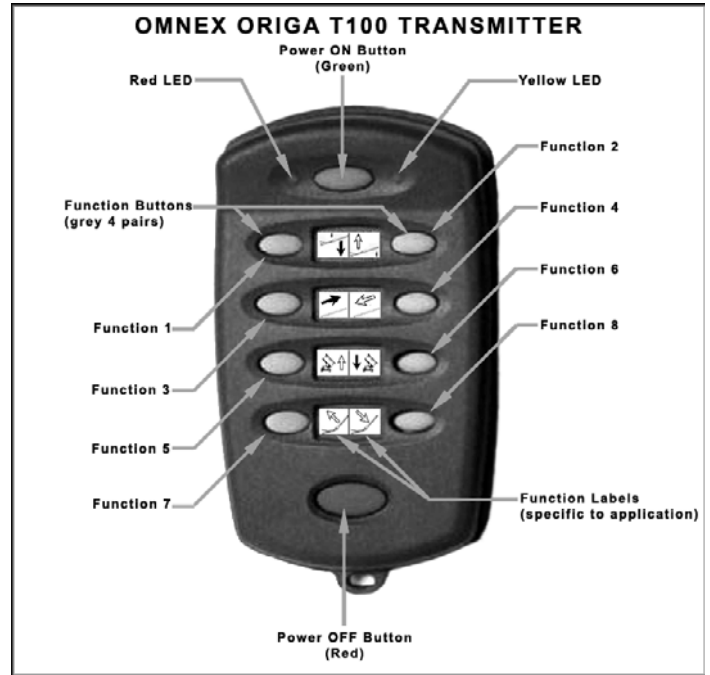
The Remote/Local switch located on the control panel will switch from manual to remote control. Switch to remote when remote control is desired.

The transmitter will stop the engine, raise and lower the conveyor (if so equipped), and start, stop and reverse the tub. If your machine is equipped with a tub cover, the remote can also raise and lower the tub cover.

### LED indicators

The yellow LED indicator is located on the upper right hand side of the radio transmitter. This LED indicates that the controller is powered up and transmitting. Light may be solid or flashing depending on mode. During normal operation this LED is flashing.

The red LED indicator is located on the upper left hand side of the radio transmitter. This LED flashes slowly to indicate the transmitter has less than twenty percent of battery capacity remaining.



When both the red and yellow LEDs are on, the transmitter is in configuration/program mode.

### Mode of operation

The Omnex Origa system has several modes of operation. The mode preset for DuraTech Industries is:

1. The Power ON (green) button powers up the transmitter. Output 9 is energized when the Power ON button is pressed
2. All functions are shut off when the Power OFF button (red button) is pressed. When the radio is restarted, all functions will be off. The transmitter will stay on until the Power OFF button is pressed.



**NOTE:** The engine will also be shut off when the Power OFF button is pressed and the remote/local switch is set on radio.

3. Output 10 is energized when any of functions 3-8 are pressed.
4. Functions 1 & 2 are interlocked latched functions and are used for tub rotation. Pressing one function will start that function. It will not stop until either button is pressed. There is a two second delay when changing tub direction.
5. Functions 3-8 are interlocked momentary functions. These are used for hydraulic cylinder functions. These functions are energized only when the buttons are pressed.

For more information on using and troubleshooting the Omnex Origa system, please refer to Section 6.4, “Troubleshooting the Omnex Wireless Remote Controls which starts on page 76.



## **Remote radio start up**

To begin using the remote radio, perform the following steps:

1. Press the green (power on) button on the transmitter. The yellow LED should start flashing to indicate that the transmitter is transmitting.
2. Set tub rotation to neutral on the machine's control panel.
3. Press the Radio start switch on the control panel and hold it in.
4. Set the radio switch on the control panel to remote.
5. Count to 5 and release the Radio start switch.



### 3.18 Grinding

Before you begin grinding, start the machine and check the direction of the tub's rotation. Also check the electronic governor for proper operation.

Watch for unusual or excessive vibration. If any occur, immediately shut off the power. Determine the cause and correct it before starting the grinder again.

In cold weather, warm up the machine for five minutes before grinding.

To begin grinding, perform the following steps:

1. Start the engine as described in "Starting the Industrial Grinder." If your HD-10P is equipped with a tub cover, then place tub cover in the fully open position.
2. Unfold the discharge conveyor and set it to the desired height.
3. Engage the conveyor run valve to the forward position.
4. If your machine is equipped with a tub cover, then set tub cover to desired position.
5. Engage the rotor clutch.



**IMPORTANT: Do Not engage clutch at high engine RPM.** Before starting the engine, rotor box should be cleared of all material. Start the engine and set the engine speed below 1000 RPM. Pull firmly and briefly on lever to "bump" the rotor and to prevent excessive clutch slippage. Fully engage the clutch only when the rotor speed is adequate to prevent overloading the engine. Run grinder with no load for a few minutes to allow clutch plates to cool off. Bumping the clutch during startup heats the clutch plates. Check periodically for proper adjustment according to the specification plate on the clutch's housing.

### 3.19 Loading the tub



**IMPORTANT:** Never drop a large object or objects into the tub from a high level. Ease the material over the edge and down into the tub carefully.

Material to be ground should be placed directly into the tub. The best method for filling the tub is:

1. Engage the rotor as described above.
2. Fill the tub about halfway full of unground material before starting tub rotation.
3. Start tub in the forward direction by switching on the electronic governor switch and engaging the tub control valve.
4. Place additional materials in the tub as needed.



### 3.19A Grinding with tub cover

The Tub Cover is designed to deflect most objects thrown out of an Tub Grinder. The movable top cover does the deflecting, and the closer it is set to the tub, the more debris it will deflect. The Tub Cover can be rotated up and down, and the support frame can be rotated in towards the tub or out away from the tub. During normal grinding, keep the tub cover as close to the tub as practical. When emptying the tub, close the tub cover until it almost contacts the tub, providing coverage of most of the tub, and stopping most of the debris as the tub empties out.

### 3.20 If lodging occurs while grinding

Materials may lodge against the side of the tub and not feed down to the rotor. If this occurs, reverse the tub direction briefly and then start the tub in a forward direction again. This practice normally dislodges any materials.



**WARNING:** Never attempt to dislodge material inside the tub when machine is in operation by manually pushing materials down. **TO PREVENT SERIOUS INJURY OR DEATH, STAY OUT OF THE TUB WHEN THE MACHINE IS IN OPERATION!**

### 3.21 Grinding wet material

Wet material is the toughest material for any grinder to handle. If possible, try to mix the wet materials with drier materials before grinding. When grinding wet material, deposit small quantities on a more frequent basis rather than filling the tub with wet material.

### 3.22 Preparing the HD-10P for transport

To prepare the HD-10P for transport over public roads, perform the

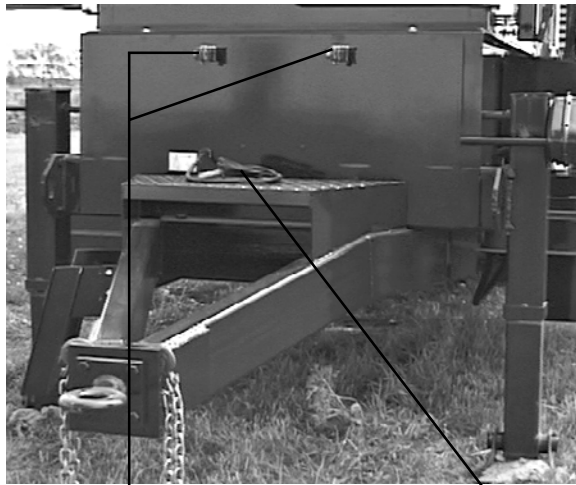
1. Be sure all loose parts such as screens, hammer rods, or extra hammers are properly stowed.
2. If the machine has folding flares, rotate the tub so the folding flares line up with the side of the machine.
3. If your HD-10P is equipped with a tub cover, then place tub cover in the fully open position.
4. If machine is equipped with folding magnetic chute, fold chute flat and secure with latch pins.



discharge conveyor in transport position



**CAUTION:** DO NOT MOVE INDUSTRIAL TUB GRINDER without first securing the conveyor in transport position as shown in the figure above.



**air brake  
connectors**

**wiring harness  
connectors**

5. Raise and fold the discharge conveyor into the transport position which is shown in the figure on the facing page. When folding the conveyor, do not exceed an engine speed of 1000 RPM. Excessive engine RPM will cause the conveyor to fold too fast and may cause damage. Be certain that no power lines, branches, roof trusses, etc. will obstruct the folding operation of the conveyor.
6. If your HD-10P is equipped with a tub cover, then lower tub cover.
7. Shut down the engine using the normal shutdown procedure.
8. Verify that the semi-tractor is properly coupled to the grinder hitch, and that the trailer wiring harness and air brake lines are properly connected to the semi-tractor.
9. Raise the trailer landing gear and lock the handle in its storage position.
10. Check the lights and the brakes for proper function.
11. Check the turning clearance between the grinder and the towing vehicle.
12. Check local ordinances regarding restrictions for machine travel on local roads.

Brackets are provided under the tub platform for wide load warning flags.

Read the towing portion of the “Safety” section in this manual.



### **3.23 Preparing the HD-10P for operation after transport**

To prepare the HD-10P for operation after transport, perform the following steps:

1. Check the location.
  - Are there power lines, branches, roof trusses, etc. that will obstruct the unfolding operation of the conveyor and the loading operation of the tub?
  - Position grinder to minimize the risk of thrown objects. For more information see section 1.6 on pages 11 & 12.
2. Lower the trailer landing gear.
3. Disconnect the wiring harness and the air brake lines from the semi-tractor.
4. Disconnect the semi-tractor from the grinder's hitch.
5. Perform pre-operation inspection of the Industrial Grinder.
6. Start the engine.
7. If your machine is equipped with a tub cover, then place tub cover in the fully open position.
8. Unfold the top section of the discharge conveyor until it is fully extended. When unfolding the conveyor, do not exceed an engine speed of 600 RPM. Excessive engine RPM will cause the conveyor to fold too fast and may cause damage. For machines equipped with folding magnetic chute, pull magnetic chute latch pins and allow chute to unfold into operating position
9. Lower the conveyor for inspection and lubrication.
10. Raise the conveyor to operating height.
11. If your machine is equipped with a tub cover, then set tub cover to desired position.

### **3.24 Preparing the HD-10P for storage**

To prepare the HD-10P for storage, perform the following steps:

1. The grinder has 4 pressure rollers with tapered roller bearings. These bearings should be checked for lubrication and adjustment annually.
2. Change the hydraulic oil and filter every 500 hours of operation.
3. To prevent rust and make inspection easier, thoroughly clean the machine.
4. Check for loose or worn chains belts, sprockets and pulleys.
5. Check the condition of bearings.
6. Make sure that the batteries are fully charged before storing the unit.
7. Change the engine oil.



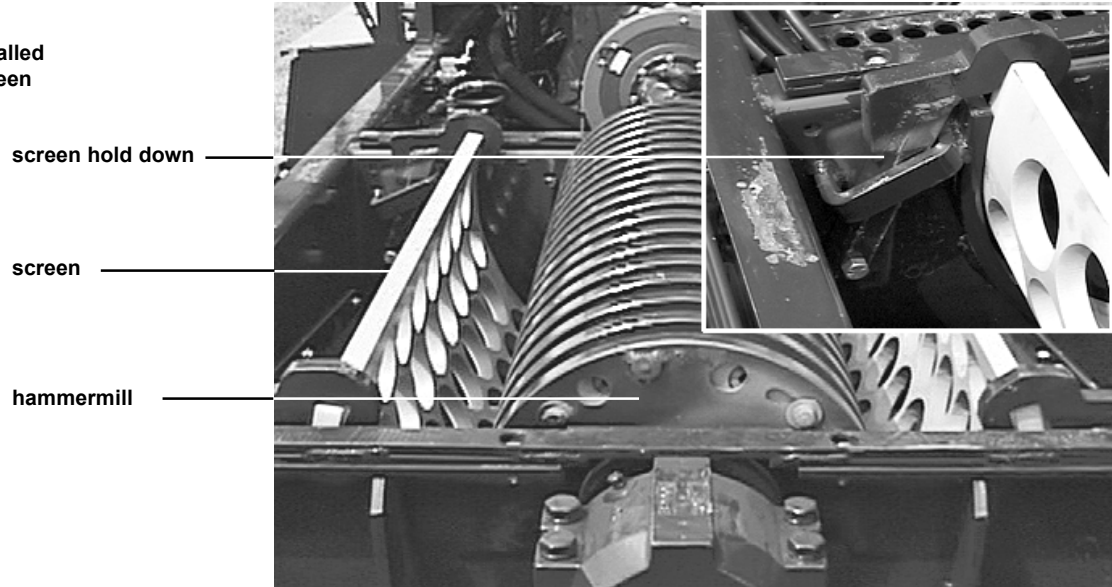


### 3.25 Removing the HD-10P from storage

To remove the HD-10P from storage, perform the following steps:

1. Perform a thorough pre-operation inspection.

figure 3.4  
hammermill, installed  
screen and screen  
hold down



### 3.26 Installing a screen



**CAUTION:** Follow normal shutdown procedure after tilting the tub and prior to performing any service work in the rotor area.

**CAUTION:** Disengage the rotor clutch, shut off the engine, remove the key and wait for the rotor to come to a complete stop before entering the tub.

To install a screen, perform the following steps:

1. Raise the tub completely, and install the hydraulic cylinder lock.
2. Raise screen hold downs and lift them back and out of the way.
3. Screens may be lifted from or placed in the machine with a hoist or lifting device.
4. Securely attach the screen to the lifting device with a sturdy chain or nylon sling. Screens can weigh over 500 lb. each, but screens which are stuck can require a force many times their weight to lift them free of the grinder.
5. Use only pry bars to guide the screens in and out of the machine. The screens are very heavy and could easily cause injury if the screen moves suddenly or is inadvertently dropped.
6. Clear all material from the screen track before installing a new screen.



7. Install the new screen using the lifting device and pry bars as explained above.

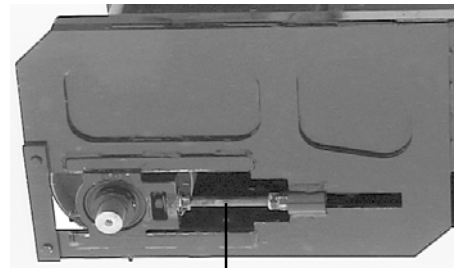


**IMPORTANT:** Make certain screen fits completely in place before proceeding to step 8.

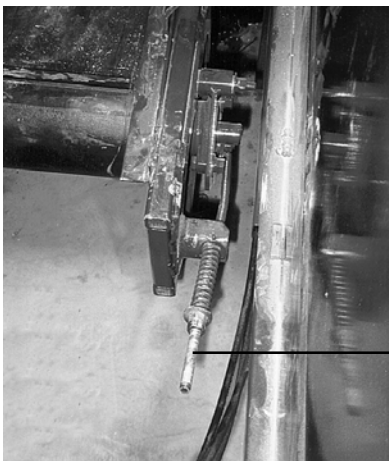
8. Return the screen hold downs to their locked position over the screens.
9. Make sure all personnel and equipment are clear of the tub platform.
10. Remove the hydraulic cylinder lock, and lower the tub.

### 3.27 Adjusting the conveyor belt tension

Both rollers on the belly conveyor and the discharge conveyor are adjustable to allow for belt stretch and tracking. If the conveyor belt slows down or stops during operation, slippage may be the cause. To eliminate slippage, tighten the adjusting bolts on the conveyor equally. This will increase the conveyor belt's tension and help to keep the belt centered on the rollers.



discharge conveyor belt adjustment bolt (one on each side of the discharge conveyor)



belly conveyor belt adjusting bolt (one on each side of the belly conveyor)



**IMPORTANT:** Do not overtighten conveyor belts. Use only enough tension to eliminate belt slippage.



## **3.28 Adjusting the conveyor belt tracking**

### **A. When a new belt is installed, use only genuine DuraTech parts.**

1. Begin by adjusting the drive roller so that the mounting bearings are the same distance from the end of the conveyor frame. This ensures that the roller centerline is square with conveyor frame. Adjust the idler roller bolts so that they are equal on both sides of the conveyor.

### **B. If the belt is running to the right side, perform the following steps:**

1. Adjust the idler roller tension bolt on the right side of the conveyor (adjustment bolts shown on previous page). Decrease tension by approximately 1/2 turn of the adjusting nut.
2. Make certain that all personnel are clear of machine and the start engine. Engage the hydraulic conveyor drive switch.
3. Observe conveyor belt tracking from a safe location.
4. If further adjustment is required, disengage hydraulic conveyor drive switch and shut down the machine using the normal shutdown procedure.
5. Some adjustment of the drive roller may be required if no improvement is noted by adjusting the idler roller tension.
6. Repeat steps 1-5 until proper tracking is achieved.

### **C. If the belt is running to the left side, perform the following steps:**

1. Adjust the idler roller tension bolt on the right side of the conveyor. Increase the tension by approximately 1/2 turn of the adjusting nut.
2. Make certain that all personnel are clear of machine and start engine. Engage the hydraulic conveyor drive switch.
3. Observe the tracking of the conveyor belt from a safe location.
4. If further adjustment is required, disengage hydraulic conveyor drive switch and shutdown using the normal shutdown procedure.
5. Some adjustment of the drive roller may be required if no improvement is noted by adjusting the idler roller tension.
6. Repeat steps 1-5 until proper tracking is achieved.



### 3.29 Sizing the tub drive chain

Tub drive chain is equipped with spring tensioned idlers which take up the slack in the chain during normal operation. Due to normal wear the tub drive chain may tend to climb on driving teeth of the tub. If this should occur, the chain should be sized to fit the tub, and the tub teeth adjusted for proper spacing in the chain.

To size the tub drive chain, perform the following steps:

1. Remove the tub drive chain from the drive sprocket. Loosen the tub teeth and wrap the chain around tub, but do not run the chain around tightener idlers or drive sprocket. Using a 1/2" bolt inserted through the chain links, draw the chain together so that the center to center measurement on link pins matches the pins on the connector link. If the distance is less than or greater than the connector link, shims must be added. Equally space shims of the same thickness and length under the chain until the proper distance is obtained. Do not add shims under the tub teeth.
2. Adjust the tub teeth so that all four sets of teeth contact the chain link on the same side of the teeth. Tighten the bolts holding the teeth in place, and return the chain to working position.

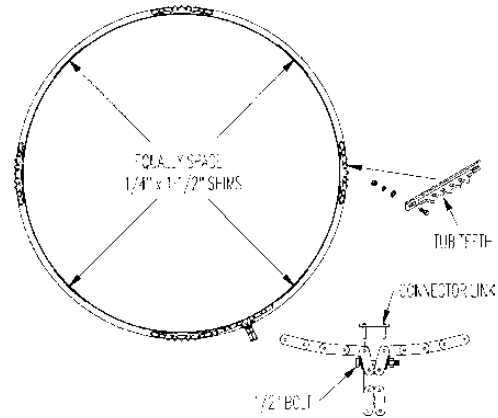
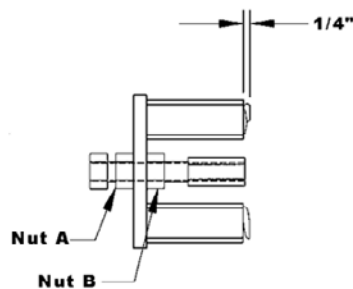
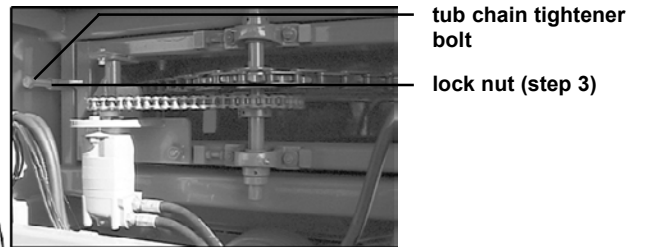
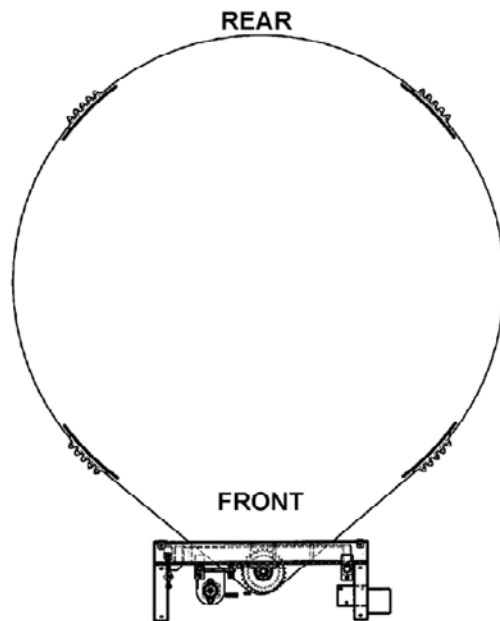
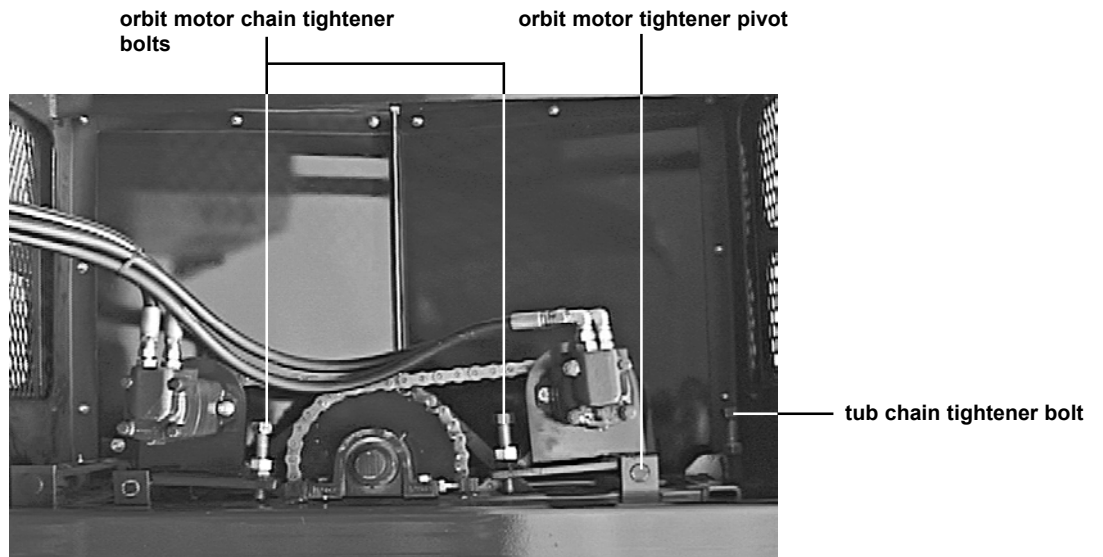




figure 3.5  
adjusting tub  
chain tension



### 3.30 Adjusting tub chain tension

To adjust the tub chain tension, perform the following steps:

1. Position tub so teeth are oriented as shown.
2. Adjust bracket - spring engagement to 1/4" to 3/8" using Nut A. Refer to figure 3.5 for illustration.
3. Tighten Nut B.

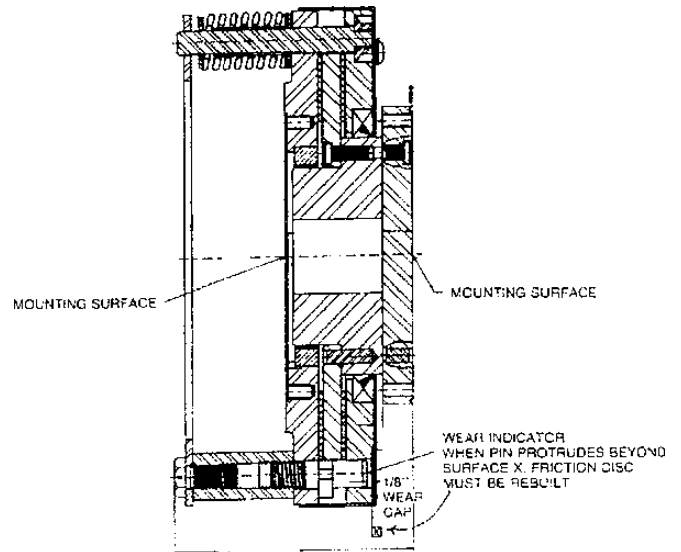


### 3.31 Checking for wear on the friction disc torque limiter

The friction disc torque limiter a unique, maintenance free, friction type, overload friction disc torque limiter which offers precise torque control.

This friction disc torque limiter requires no routine maintenance, and it can be allowed to wear until the wear indicator becomes flush with the face surface “X” of the pressure plate.

The wear indicator should be checked as required by the application. The output hub should be rebuilt or replaced when the clutch is deemed to be worn out. If the friction disc torque limiter continues to wear and the wear indicator protrudes, then the friction disc torque limiter’s torque capacity may drop rapidly.



**WARNING:** The spring bolts contain heavy springs which are highly compressed . They should not be tampered with. DO NOT attempt to disassemble the spring bolts. If a spring bolt is damaged, dispose of it in a safe manner.



wear indicator



### 3.32 Engaging and adjusting the rotor clutch

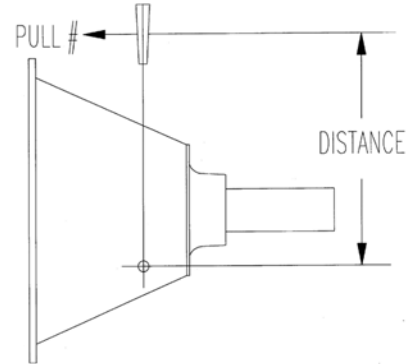


**IMPORTANT:** Read and have a thorough understanding of the clutch’s operators manual and the specification plate found on the clutch’s housing.

**IMPORTANT:** Do Not engage the clutch at high engine RPM.

To engage the clutch, perform the following steps:

1. Before starting engine, the rotor box should be cleared of all material.
2. Start the engine and set the engine speed below 1000 RPM.
3. In order to prevent excessive clutch slippage, pull firmly and briefly on the clutch engagement lever to “bump” the rotor. Fully engage the clutch only when the rotor speed is adequate to prevent overloading the engine.
4. Run grinder with no load for a few minutes to allow clutch plates to cool off. Bumping the clutch during startup heats the clutch plates.
5. Check periodically for proper adjustment according to the specifications plate on clutch’s housing.



CLUTCH	PULL	DISTANCE	TORQUE
SP214	161-122 lb	21-1/2 in.	289-219 ft. lb
SP314	161-122 lb	21-1/2 in.	284-219 ft. lb
SP318	290-220 lb	28 in	678-513 ft. lb

**DAMAGE DUE TO EXCESSIVE SLIPPING WILL NOT BE COVERED BY THE WARRANTY.**

A new clutch generally requires several adjustments until friction surfaces are worn in. Do not let a clutch slip as this will glaze the friction plates and may ruin them. A new power take off should have its clutch adjustment checked frequently during the first ten (10) hours of service.

If the clutch slips or overheats, the clutch must be adjusted.

To adjust the clutch, perform the following steps:

1. Use the normal shutdown procedure to shut down the engine before performing any clutch adjustments.



**CAUTION:** If the clutch has been allowed to slip, the clutch components can be very hot. Allow parts to cool before performing any adjustments.

2. Remove the hand hole plate from the housing, and rotate the clutch until the adjusting lock pin can be reached.
3. Disengage the adjusting lock pin and turn the adjusting ring until the operating lever shaft requires the amount of torque listed in figure above. The amount of torque should be the higher value listed for your clutch model’s torque range.
4. Perform this adjustment again when the torque value drops below the smaller value listed in the same table.



### 3.33 Electro-hydraulic valve coil test

See the figure 3.6 for the location of the electro-hydraulic valve coil.

This test requires an accurate ohm meter. Disconnect the wiring harness leads at the electro-hydraulic valve coil. Check resistance of valve coil leads at the terminals. The resistance should be between 8 to 12 ohms for a 12 volt system, and 39 to 44 ohms for a 24 volt system. If the values are not within this range, replace the electro-hydraulic valve coil.

#### MANUAL OVERRIDE



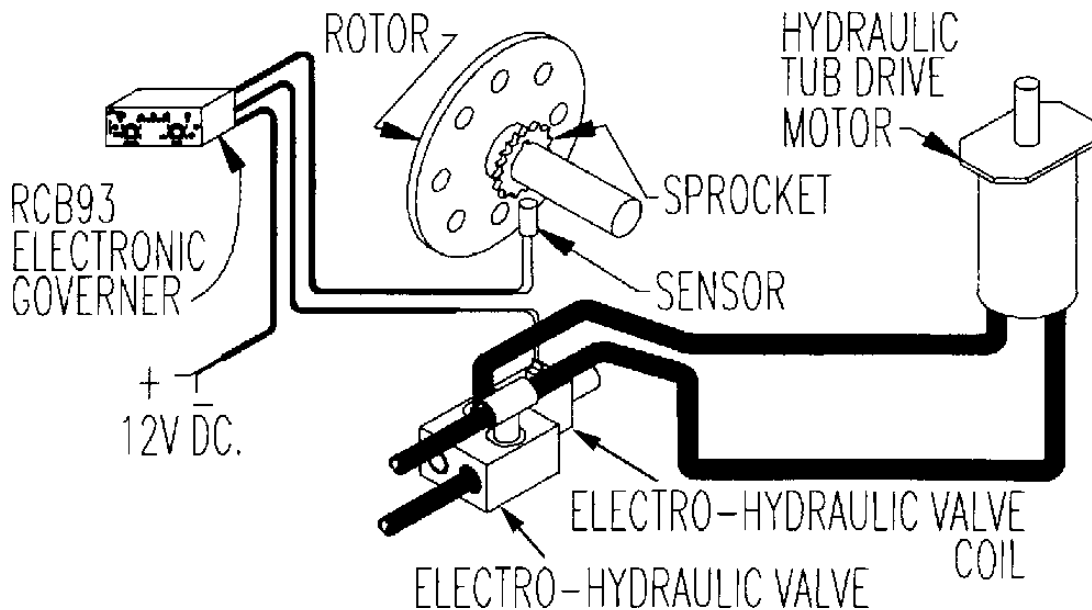
**NOTE:** If there is an electrical failure with the machine, it may still be able to grind. Switch the electronic governor off. Remove the rubber end cap and loosen the jam nut on the electro-hydraulic valve. Start the machine and engage the tub drive.

**IMPORTANT! - DO NOT ENGAGE THE ROTOR CLUTCH AT THIS TIME!**

Turn the adjusting stud clockwise until the tub rotates at the desired speed. Lock the jam nut on the adjusting stud and replace the rubber end cap on the electro-hydraulic valve. When the electro-hydraulic valve is adjusted in this manner, it will function only as a manual flow control. The grinder will now operate as it would if the electronic governor were switched to the tub (manual) mode. The tub speed will be constant and it will not change to match varying load conditions.

Contact your dealer for future repairs or replacement parts. When the problems are corrected, calibrate the electro-hydraulic valve.

figure 3.6  
electronic governor  
system

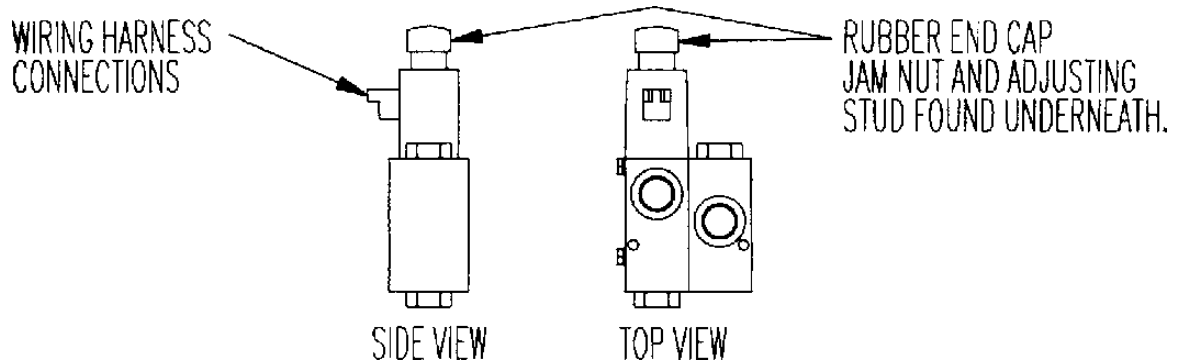




### 3.34 Electro-hydraulic valve calibration



**IMPORTANT:** Stay clear of all moving parts while calibrating the electro-hydraulic valve. **The tub will be rotating during this adjustment.**



To calibrate the electro-hydraulic valve coil after following the three steps above, perform the following steps:

1. Remove the rubber end cap from the end of the electro-hydraulic valve. This will reveal a jam nut and an adjusting stud with a screwdriver slot.
2. Disconnect the wiring harness from the electro-hydraulic valve coil, and loosen the jam nut.
3. Start the engine, and engage the tub drive in the forward direction. Throttle the engine up to a fast idle. **Do not engage the rotor clutch!**
4. If the tub is not rotating, turn the adjusting screw clockwise until it bottoms out. Turn the adjusting screw counterclockwise until the tub stops. The electro-hydraulic valve is now calibrated.
5. Lock the adjusting screw with the jam nut and replace the rubber cap. Shut down the machine using the normal shutdown procedure in this manual. Reconnect the wiring harness to the electro-hydraulic valve coil.



## Section 4: Engine Maintenance

Engine oil level, engine coolant level, air filters, and fan belt tension should be checked daily. All debris, wood chips, paper, and combustible or ignitable material should be cleared from the engine compartment daily or more often as conditions warrant. When cleaning the engine compartment, pay particular attention to the top of the engine. Follow the engine manufacturer's recommendations for the replacement of parts and fluids, and follow the manufacturer's recommended maintenance schedule. Engine specifications should be found in the Operation and Maintenance manual for the engine.

## Section 5: General Maintenance



**WARNING:** Before servicing machine, read the Service and Maintenance section of the Safety Instructions.



**IMPORTANT:** If for any reason arc welding is to be done, always ground rotor to frame of machine to prevent arcing in bearings.

### 5.1 Welding Procedure

Proper welding procedures are necessary in order to avoid damage to the engine Control Module (ECM) sensors, and associated components. If at all possible, the component that is to be welded should be removed from the machine for welding. If removal of the component is not possible, the following procedure must be followed when welding on a machine that is equipped with electronic engine. This procedure is considered the safest and should provide minimum risk of electronic component damage.



**NOTE:** Do not ground the welder to electrical components such as the ECM or sensors. Improper grounding can also damage the drive train bearings or hydraulic components. Clamp the ground cable from the welder to the component that will be welded. Place the clamp as close as possible to the weld. This will help reduce the possibility of damage.

1. Stop the engine. Turn the switched power to the OFF position.
2. Disconnect the negative battery cable from the battery.
3. Disconnect the connectors from the ECM. Move the harness to a position that will not allow the harness to accidentally move back and make contact with any of the ECM pins.



4. Connect the welding ground cable directly to the part that will be welded. Place the ground cable as close as possible to the weld in order to reduce the possibility of welding current damage to the bearings, hydraulic components, electrical components, and ground straps.



**NOTE:** If the electrical/electronic components are used as a ground for the welder, or electrical/electronic components are located between the welder ground and the weld, current flow from the welder could damage the components.

5. Protect the wiring harness and hydraulic hoses from welding debris and spatter.
6. Use standard techniques to weld the materials.

## 5.2 Batteries

Check the condition of the batteries to insure that the electrolyte level is correct. Make sure that the terminals and cables are not corroded, and that the battery is held in place properly. Also make sure there is no arcing or grounding by the terminals.

The system uses two 12 volt batteries in series to produce a 24 volt system for the engine.



**CAUTION:** Hydrogen gas given off by a battery is explosive. Keep sparks and flames away from the battery. Before connecting or disconnecting a battery charger, turn the charger off. Make last connection and first disconnection at a point away from the battery. Always connect the NEGATIVE(-) cable last and disconnect the NEGATIVE(-) cable first.

## 5.3 Lubrication



**CAUTION:** Always shut off machine before adjusting or lubricating. When grinder is operated during cold weather, all lubrication should be performed after bearings are at operating temperatures.

Since a full bearing with a slight leakage is the best protection against entrance of foreign material, bearings operating in the presence of dust and water should contain as much grease as speed will permit. At higher speed ranges, too much grease will cause the bearings to overheat.

Abnormal bearing temperature during high speed operation may indicate faulty lubrication. The normal temperature may range from cool to warm to the touch. If a bearing is too hot to touch for more than a few seconds and the bearing is leaking grease excessively, there is too much grease in the bearing. High bearing temperatures with no grease showing at the seals, particularly if the bearing seems noisy, usually indicates too little grease. Normal temperature and slight showing of grease at the seals indicate proper lubrication.

The Lubrication Chart is a general guide for “relubrication”. Certain conditions may require a change of lubrication periods as dictated by experience.

A heavy-duty, general-purpose, lithium-based grease is recommended for lubricating the HD-10P Industrial Tub Grinder.

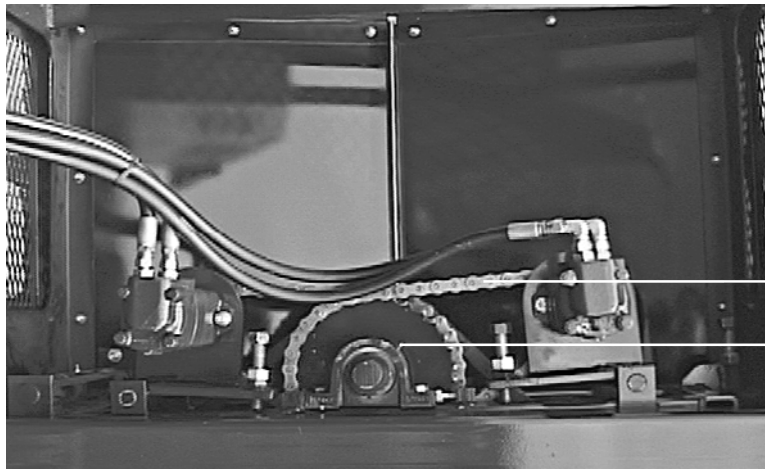


# LUBRICATION CHART

LOCATION	NO. OF ZERKS	FREQUENCY
Rotor Brg, Check oil Level		Daily
Wheel Bearings, check oil level		Daily
Roller Chains		Oil Daily in Dusty Conditions
Tub Chain Tightener Pivot	1	40 Hours
Tub Drive Orbit Motor Pivots	2	40 Hours
Tub Drive Shaft	2	40 Hours
Clutch Lever Jack Shaft	2	40 Hours
Discharge Conveyor rollers	4	40 Hours
Discharge conveyor pivot	2	40 Hours
Belly Conveyor	4	40 Hours
Drive Line	3	40 Hours
Tub Pivot, 90 Deg Tub Tilt	2	40 Hours
Jacks	4	40 Hours
Tub Cover - Pivot Points	4	100 Hours
Main Clutch Bearing	1(Approx. 10 grease gun shots)	100 Hours
Operating Shaft - Clutch	2(Approx. 1 grease gun shot each)	100 Hours
Throw Out Collar - Clutch	1(Approx. 1 grease gun shot)	100 Hours
Rotor Brg, change oil		500 hours
Tub Pressure Roller:Inspect and Repack		1000 Hours
Main Clutch Bearing: Inspect and Repack		4000 hours or 2 years, whichever comes first

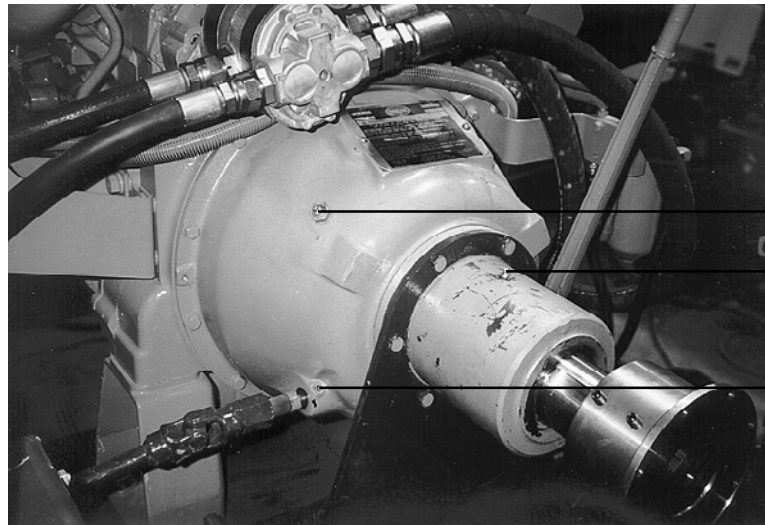


figure 5.1  
roller chain and  
tub drive shaft  
lubrication points



roller  
chains  
tub drive shaft  
lubrication zerk

figure 5.2  
operating shaft-  
clutch, main clutch  
bearings, throw  
out collar-clutch  
lubrication points



lubrication  
zerks  
  
throw out  
collar-clutch  
  
main clutch  
bearings  
  
operating shaft clutch

figure 5.3  
discharge conveyor  
roller, discharge  
conveyor pivot and  
belly conveyor roller  
lubrication points



belly conveyor roller  
  
lubrication zerks  
  
discharge conveyor roller  
  
discharge conveyor pivot



## 5.4 Pressure roller lubrication

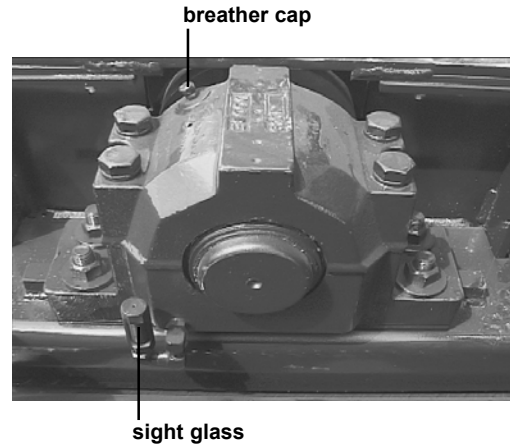
The grinder has a pressure roller with tapered roller bearings. These bearings should be checked for lubrication and adjustment every 1000 hours of operation or annually whichever comes first.

## 5.5 Rotor bearing lubrication

As a general rule, rotor bearing oil should be replaced every 500 hours of operation. However, if the oil becomes discolored or milky in appearance, the oil should be replaced immediately.

The static oil level should bring oil to the centerline of the bottom roller. The oil level in the sight glass should be 1-13/16" above the base housing. See Figure at right for more information.

When adding or replacing rotor bearing oil, use Mobil SHC-626 oil or other similar oil, but never use a detergent motor oil.



## 5.6 Hydraulic system

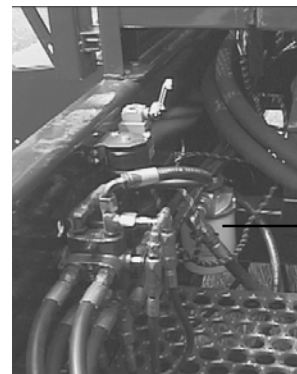


**CAUTION:** Lack of proper hydraulic oil level in the reservoir tank will cause system to heat under continuous running. Check the hydraulic oil level daily and replace as necessary.

Both hydraulic oil filters should be changed after the first 10 hours of operation. Change hydraulic oil and filters after the first 100 hours of operation. Thereafter, change hydraulic oil filters every 500 hours and change hydraulic oil and filters at least every 1000 hours of operation.

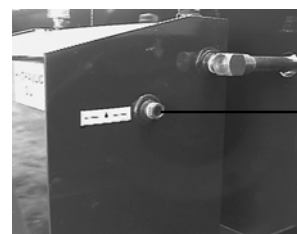
Check the hydraulic oil regularly, and if the oil has a burnt smell or milky appearance, change it immediately.

DuraTech Industries recommends using Conoco Hydroclear Power Tran Fluid if your machine has a Hydroclear decal on the hydraulic tank. Other acceptable fluids include Mobil 423, Farmland Super HTB, or other similar fluids. If the hydraulic tank does not have this decal, then all of the above fluids are acceptable.



hydraulic oil filter

**NOTE:** There are 2 hydraulic oil filters which are straight across from each other.



hydraulic oil level sight glass



## 5.7 Axle, wheels and tires

### TIRE PRESSURE

Set the tire pressure according to the manufacturer's specifications. The appropriate tire pressure can be found on the sidewall of the tire.

### WHEEL BEARINGS

The wheels have tapered roller bearings in an oil bath. Each hub is equipped with a transparent oil cap which has an oil level indicator mark that allows for easy checking of the oil level. The oil level should be checked daily during the pre-operation inspection. This lubrication method assures long bearing life with proper maintenance of the oil level.

When adding or replacing oil in the wheel bearings, use SAE 80W-90 HYPOID GEAR OIL.



tires are 215/75 R 17.5      oil level indicator

## 5.8 Brake component lubrication

A schedule for the periodic lubrication of brake components should be established by the operator on the basis of past experience and the severity of operating conditions.

### GUIDELINES

- **For camshaft roller journals:** Lubricate with high temperature anti-seize grease.
- **For anchor pins:** Lubricate with high temperature anti-seize grease.
- **For manual slack adjusters:** Lubricate with NLGI Grade 2.
- **For automatic slack adjusters:** Lubricate with ASA manufacturer's recommended lubricant.



## FREQUENCY OF SERVICE

Camshaft roller journals, anchor pins, slack adjusters every 25,000 to 30,000 miles or every six months depending on severity of operating conditions. (For off highway use: service every 4 months depending on severity of operating conditions.)



**CAUTION:** Care must be exercised when lubricating the camshaft bushings and anchor pins. Over lubrication could cause a safety problem as brake linings become saturated with lubricants.



**NOTE:** When reline shoe linings become saturated with grease, replace with new shoe and lining assemblies.

## SUGGESTED PREVENTATIVE MAINTENANCE

- **Every 1,000 miles:** Check oil level in wheel hub and inspect wheel for leaks.
- **Every 15,000 miles:** Check brake adjustment. Repack wheel bearings (grease application).
- **Every 25,000 to 30,000 miles:** Check lining wear and estimate reline time. Inspect camshaft, camshaft spider bushing and camshaft support bracket bushing for any signs of wear. Lubricate brake actuating components.
- **Every 100,000 miles, once a year, or at brake reline:** Replace wheel bearing lubricating oil (if applicable). Check brake air chambers and slack adjusters. Inspect brake rollers, roller shafts, anchor pins and bushings and replace if necessary.





## 5.9 Rotor bearing installation



**WARNING:** To ensure the rotor is not unexpectedly started, turn off and lock out or tag the power sources before proceeding. Failure to observe these precautions could result in bodily injury.



**NOTE:** Bearing housing caps and bases are not interchangeable and must be matched with mating half. Install the non-expansion bearing first.

1. Apply a light coating of oil or other rust inhibitor to the adapter area of the shaft.
2. Measure the internal clearance of the bearing before mounting. Place the bearing in an upright position. Seat the inner ring and roller elements by pressing down firmly on the inner ring bore while rotating the inner ring a few times. Position the roller assemblies so that a roller is at the top most position on both sides. Using a feeler gauge measure the clearance on both sides of the roller by inserting the feeler gauge as far as possible and sliding over the top of the roller. Write down the measured clearance for use in step 3E.



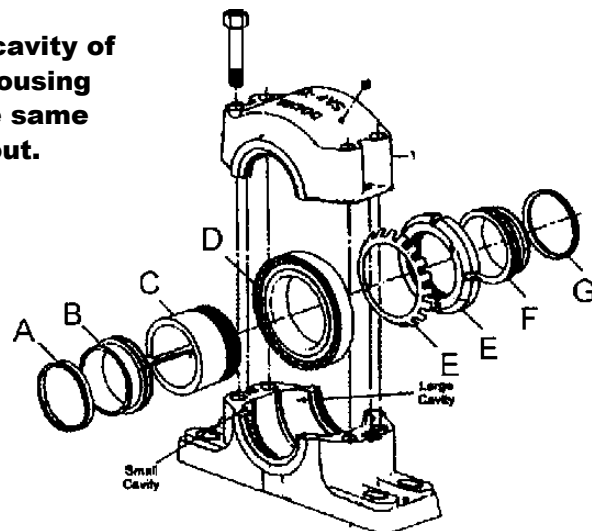
**NOTE:** Do not rotate bearing when the moving feeler gauge is between the roller and the outer ring.

3. Install the bearing parts in the following sequence.



**NOTE:** There is only one way to correctly install the bearing. Refer to Figure below for illustration.

**NOTE: Large cavity of Pillow Block Housing must be on the same side as knockout.**





### A. V-ring Seal

Slide one of the V-ring seals onto the shaft, making sure the lip is toward the bearing. Set aside until step 11.



**NOTE:** Do not install the V-ring seal on the seal until the housing cap has been set in place and tightened.

### B. Seal Ring

Install a seal ring on the shaft with the largest OD toward bearing.

### C. Adapter

Slide the adapter onto the shaft, with the threaded end outboard, to the approximate location of the bearing. Apply a light coating of oil to sleeve OD. Do not use grease.

### D. Bearing

Make sure that the roller clearance has been written down. Install the bearing on the adapter sleeve with the large end of the tapered bore first. Locate the bearing in the proper position on the shaft. Before tightening refer to Figure on the previous page

### E. Lockwasher and Locknut

Install the lockwasher on the adapter with the inner prong located in the slot and facing toward the bearing. Install the locknut, with the chamfered face toward the bearing. Tighten the locknut using a spanner wrench and hammer until the clearance noted in step 2 is reduced by 0.0018 to 0.0025 inch. During this step, the shafts should be supported, so that all weight is off of the bearing. Find a lockwasher tab that aligns with a locknut slot and bend the tab into the slot. If the slot is past the tab then tighten the locknut to meet a washer tab.

### F. Seal Ring

Install a second seal ring with the large OD toward locknut.

### G. V-Ring Seal

Slide the second V-ring onto the shaft, again making certain that the lip is toward bearing.



**NOTE:** Do not install V-ring seal on seal ring until housing has been set in place and tightened. See Step 11.

4. Remove any paint, dirt or burrs from the mating surfaces of the housing halves. Thoroughly clean the seal grooves on both sides. Set the lower half of housing on the base with all four cap bolts in place, and apply oil to the bearing seats. Apply grease to the seal grooves in the lower housing.

Be sure the housing is positioned as shown in Figure on facing page view relative to adapter nut.



5. Apply lubricant to the bearings and the seal rings. The lubricant should be smeared between the rolling elements. Use Mobil SHC-626 or similar oil for bearing lubricant. Do not use detergent motor oil!
6. Place the shaft with the bearing into lower half of the housing while carefully guiding the seal rings into the housing grooves.
7. Bolt the lower half of the non-expansion bearing housing to the base. Move the shaft endwise so that stabilizing ring can be inserted between the bearing's outer ring and the lower half shoulder of the housing on same side as the locknut. Make all other bearings on the same shaft expansion bearings by centering in the middle of their housing seat. Bolt the expansion housings to base.



**NOTE:** Only one bearing per shaft is non-expansion, other bearings should be expansion.

8. When a closed end is required, the end plug supplied should be fit into the center seal ring groove of the housing.
9. Lubricate the bearing seal grooves in the housing cap and place over the bearing after wiping the mating surfaces. The two dowel pins will align the cap with the lower housing half.



**NOTE:** Each cap must be matched with its mating lower half, as these parts are not interchangeable.

10. Tighten the cap bolts and nuts to 208 to 260 ft-lbs.
11. Make sure that there is enough seal running clearance, and then install V-ring seals onto the seal rings and coat the V-ring seals with grease.
12. Misalignment of the pillow blocks must not exceed 1/2°.

## 5.10 Rotor bearing maintenance



**WARNING:** To insure that drive is not unexpectedly started, turn off and lock out or tag power source before proceeding. Failure to observe these precautions could result in bodily injury.

Remove the housing cap in order to inspect the bearing and lubricant. Before reassembly, it is important that the V-ring seals be removed. This will ensure that the seal lip will not be damaged while setting the cap in place. Reassemble the rotor bearing using steps 9 through 11 above.

### Seal Replacement

When removing a bearing it is recommended that V-ring seals and seal rings be replaced.



## 5.11 Hammermill maintenance

Visually examine the mill to see if any of the internal parts show excessive wear. These parts should include liners, rotor discs and the holes in the discs that support the rods. Enlarged holes can cause rods to break or bend. Also check rods, rod locking or retaining devices, hammers, screens, screen tracks and hold downs, main shaft, platform locking devices, hinges or anything else that could wear and perhaps fail and causing damage to the hammermill and/or personnel if not properly maintained. The bearings and motor alignment should also be checked along with mounting bolts to insure a firm foundation and reduced vibration.



**CAUTION:** Keep all foreign objects out of the tub and away from the mill. Foreign objects may result in personal injury or damage to the machine.

The hammers are designed to grind products such as paper or wood waste, chips, sawdust, shavings, or hogged materials that may be reduced in size in a hammermill. The hammers are not designed to grind or crush hard materials such as coal, minerals, metals, rock, or other incompressibles, which could cause parts to fail. These materials should never be allowed to enter a hammermill.

The hammers have been designed and manufactured to provide the best compromise between hardness for good wearing qualities and strength for dependability and resistance to breakage.



**WARNING:** The hammers have been heat treated, and any alteration of the hammers by heating, grinding, resurfacing or any other process can change the mechanical properties of the hammer and make it unsuitable or dangerous to use.

Because of the high capacity of the machine, the hammers will wear and must be considered expendable. Each hammer has two cutting edges. For maximum life, it is suggested that hammers be rotated periodically to even out the wear over the entire rotor. If one end of a hammer is allowed to wear too long, one of the hammer's cutting edges will be lost.

Screens also have two cutting edges. When cutting edges become rounded, the screen can be turned end for end exposing the new cutting edges. The results of badly worn hammers and screens is loss of capacity, and added horse power requirements.

Hammer rods are case hardened to maximize wearability and toughness, although hammer rods must be considered expendable.



**NOTE:** Hammer and hammer rod life can be extended by keeping rotor rotating at 2000 RPM. Over powering or over feeding the rotor will cause the swinging hammers to lay back resulting in excessive wear on both the hammers and the rods.



## 5.12 Fixed hammer maintenance and replacement



**CAUTION:** Disengage the driveline clutch. Shut off the engine. Remove the key before working on the rotor.



**IMPORTANT:** The bolts on the hammer tips should be checked periodically for proper torque. Torque ratings for two bolt tips are listed below.

When replacing hammer tips, We recommend the following:

- A. Always replace fixed hammer tips in pairs, 180 degrees apart (same as with the swinging hammers, illustrations A & B figure 5.4).
- B. Tips placed 180 degrees apart should be the same weight.
- C. When starting the hammermill after installing a new set of tips or after turning the tips to expose new faces, watch for unusual or excessive vibration. If any is noticed, shut off the hammermill. Determine the cause and correct it before starting the mill again.

To replace the hammer tips on machines with fixed hammers, perform the following steps:

1. Be sure to disengage the clutch, shut down the engine, and remove the key.
2. Identify the tips to be removed, then loosen and remove the bolts and tips.
3. Rotate or replace tips. Use new bolts and lock nuts when replacing tips.
4. **FIXED HAMMER TORQUE SPECIFICATIONS**

For two-bolt tips with 5/8" NF grade 8 bolts and grade 8 lock nut, Torque to 190-210 ft.lbs.

5. After 2 hours of grinding, retighten the bolts to the same torque values.
6. Periodically retighten the bolts to the same torque values.



## 5.13 Swinging hammer replacement and maintenance



**CAUTION:** Disengage the PTO, shut off the engine and remove the key before working on the tub.

When installing or changing hammers, be sure to follow the hammer diagram carefully. Misplacement of the hammers could cause excessive vibration. We recommend that hammers be balanced in sets according to the rod on which they are to be installed. Sets of equal weight should be installed 180 degrees apart (See Illustration A). When replacing a worn or broken hammer with a new hammer always install a second new hammer 180° away from the first (see Illustration B). When starting the hammermill after installing a new set of hammers or turning corners, watch for unusual or excessive vibration. If any occurs, immediately shut off the mill. Determine the cause and correct it before starting the mill again.

To replace worn hammers on machines with swinging hammers, perform the following steps:

1. Follow the normal shutdown procedure which can be found on page 24 of this manual.
2. Loosen the four bolts at the rear of the rotor which holds the hammer rod retainer plate in place.
3. Rotate the retainer plate to align holes allowing the hammer rods to be removed through the rear of rotor.
4. Remove one row of hammers and replace individual hammers as necessary. Note the location of any spacers. See hammer spacing charts.
5. After all the hammers have been replaced, rotate the retainer plate to lock hammer rods in place, and tighten the four retainer plate bolts.



**IMPORTANT:** Care should be exercised when replacing only a few hammers and not the entire set. If one or more new hammers are inserted on a rod, the same number of new hammers should be inserted on the rod directly across the rotor. This will maintain a balanced rotor for vibration free operation.

figure 5.4  
hammer  
replacement  
illustrations A + B

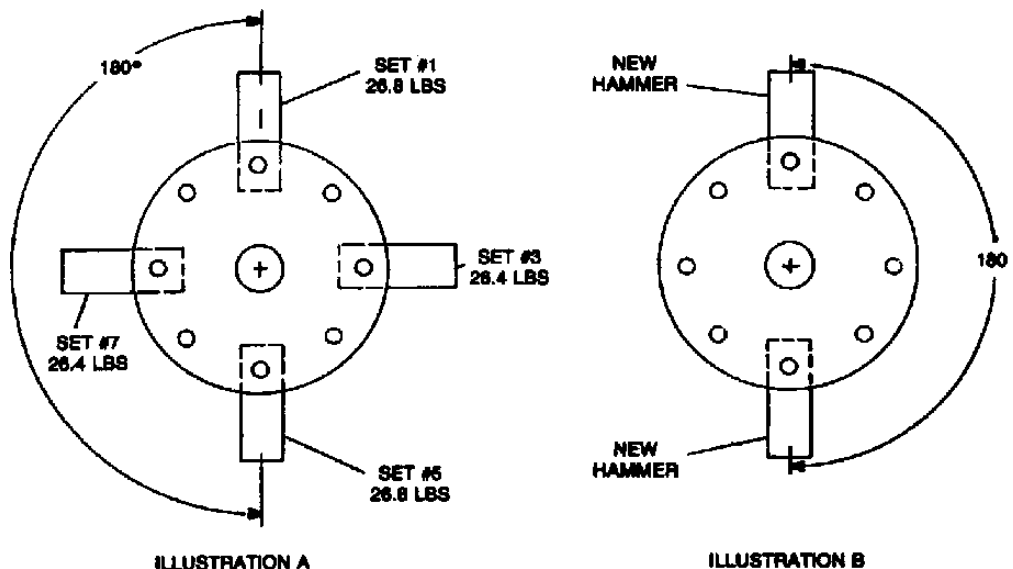




figure 5.5  
1/2 set swinging  
hammer spacing

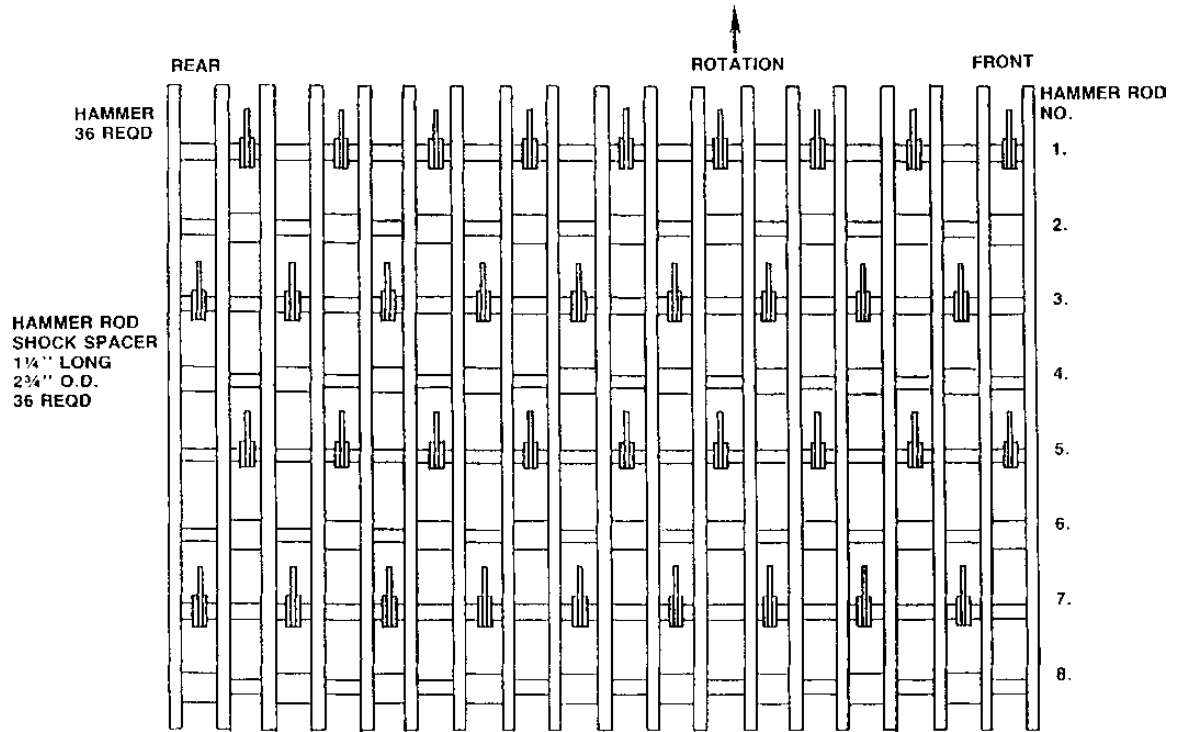


figure 5.6  
full set swinging  
hammer spacing

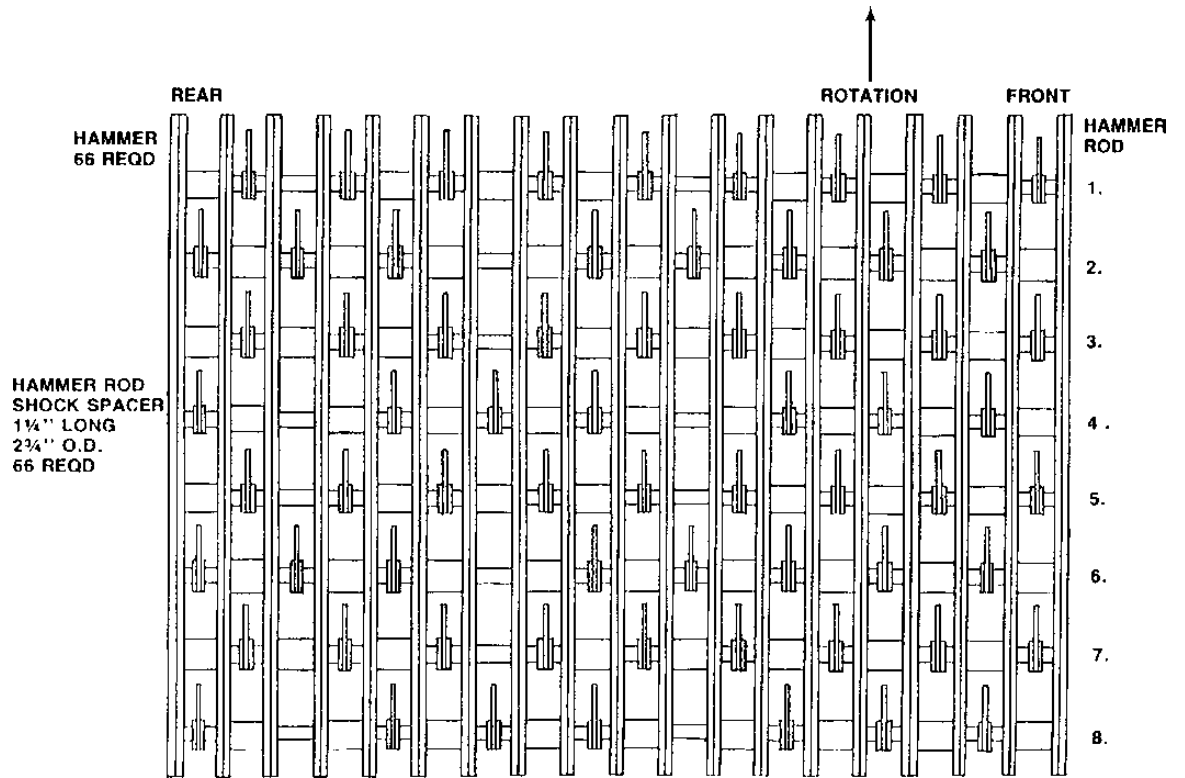




figure 5.7  
fixed hammer spacing

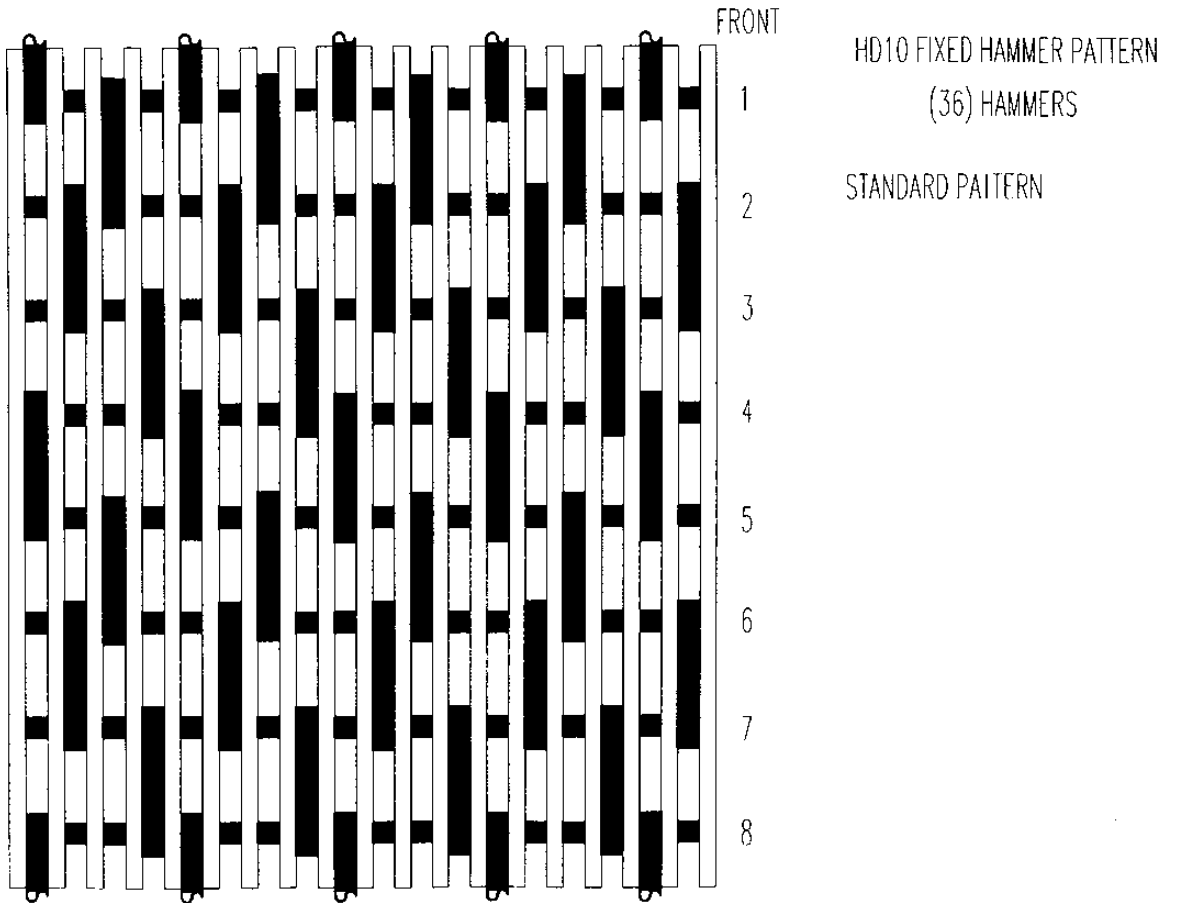


figure 5.8  
fixed hammer spacing  
V pattern

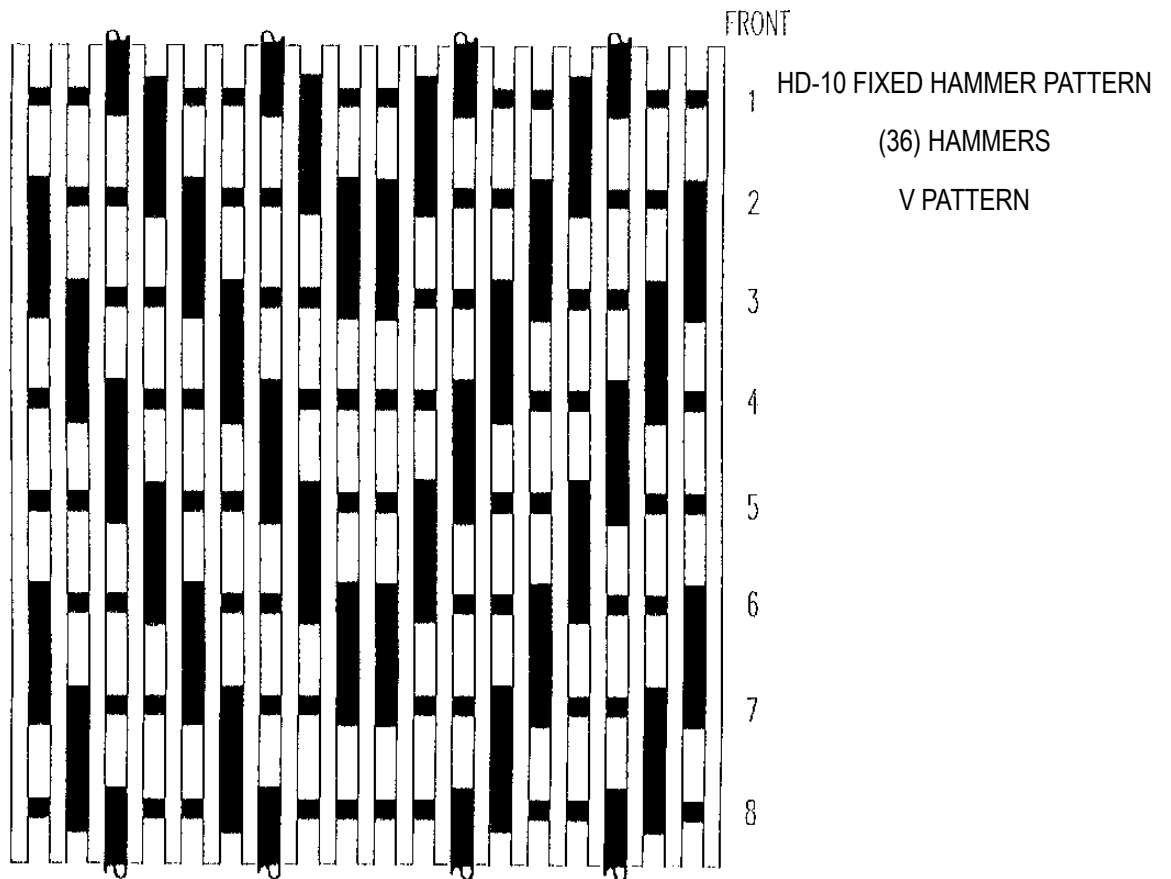
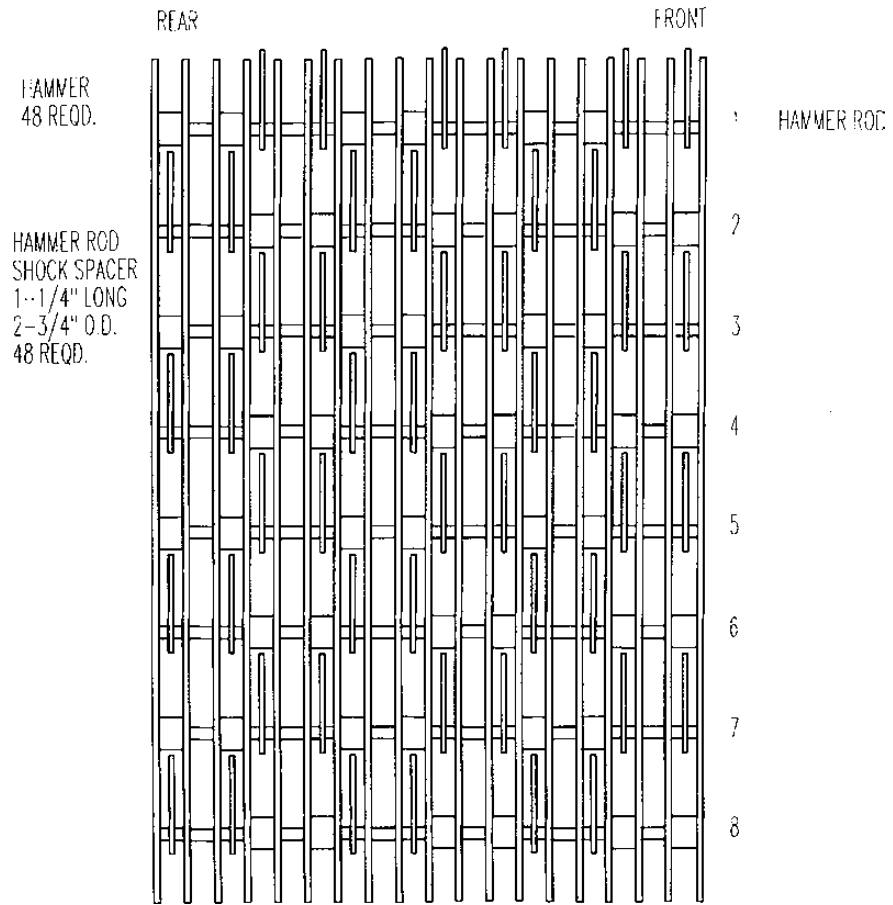






figure 5.9  
mill grate hammer  
spacing





## **Section 6: Troubleshooting the HD-10P**

### **6.1 Troubleshooting the electronic governor system**

1. When power is reaching the electronic governor the fuse light should be on. If this light fails to go on, check the fuse, the battery connections, the wiring harness, and the indicator lamp. If the fuse light is on, the wiring harness, battery connections, fuse and bulb are functioning correctly.
2. Checking the TUB MODE operation of the electronic governor. With the engine and hydraulic systems at operating temperature, and the tub drive control valve in the forward position, throttle the engine up to 1800-2000 RPM.

With the mode switch in the TUB MODE position, the tub should be rotating. The speed of the tub can be varied by rotating the tub limit knob. The number of tub speed lights which are lit will vary with the setting of the tub limit knob. If the number of tub speed lights lit varies as you rotate the tub limit knob, the manual portion of the controls are functioning correctly. Proceed to step 3. If the manual portion is not working properly, proceed to troubleshooting table 6.1.



table 7.1 troubleshooting the electronic governor in tub mode

PROBLEM	CAUSE	REMEDY
<p>1. The tub does not rotate but the electronic governor and the manual hydraulic valve are working properly. There is pressure to the orbit motor.</p>	<p>1. The tub is binding.            2. There is too much material in tub.            3. The tub is overloaded due to wet or tough grinding material.            4. The pressure relief valve in the control valve set too low or is faulty.</p>	<p>1. Remove the material causing problem.            2. Reduce the amount of material in the tub.            3. Check oil pressure.</p>
<p>2. The tub does not rotate, but the valve is receiving 18 to 24 volts of DC power. There is no pressure to the orbit motor. Note: The valve refers to the valve where you disconnect the wiring harness. For more information see "Electronic governor hardware test" later in this section.</p>	<p>1. The manual hydraulic valve is not engaged.            2. The valve assembly is dirty or faulty.            3. The solenoid is faulty.</p>	<p>1. Engage the manual hydraulic valve.            2. Clean or replace the valve assembly.            3. Test the solenoid and replace as necessary.</p>
<p>3. The tub does not rotate, and there is no voltage to the valve.</p>	<p>1. There is no power to the electronic governor.            a. The electronic governor is switched off.            b. The fuse is blown.            c. The tub limit knob is set fully counterclockwise.            2. A wire in the wiring harness is broken.            3. The electronic governor is faulty.</p>	<p>1. a. Switch the electronic governor mode switch to tub.            b. Replace the fuse.            c. Turn the tub speed knob clockwise.            2. Replace or repair the wiring harness.            3. Replace the electronic governor.</p>
<p>4. The tub runs with the electronic governor switch off. Disconnect the wiring harness at the valve.            A. If the tub stops            B. If the tub keeps turning</p>	<p>1.A. The electronic governor is out of adjustment.            2.A. The electronic governor is faulty.            1B. The valve override screw is adjusted in too far.            2.B. The valve is faulty.</p>	<p>1.A. Readjust the electronic governor.            2.A. Replace electronic governor.            1.B. Adjust the override screw.            2.B. Replace the valve.</p>
<p>5. The tub speed can not be varied with the tub limit knob.</p>	<p>1. Valve override is adjusted in too far.            2. The valve is stuck.            3. The solenoid is stuck.            4. The electronic governor is faulty.</p>	<p>1. Adjust the override screw.            2. Clean or replace the valve assembly.            3. Test the solenoid and replace as necessary.            4. Replace the electronic governor.</p>



3. Checking the ENGINE MODE operation of the electronic governor. If the tub mode controls function correctly after following the tub mode trouble shooting check list, then follow the calibration instructions on page 31 of this manual. If the tub will not rotate, proceed to trouble shooting table 6.2.

**Table 6.2 Troubleshooting the electronic governor's engine mode**

<b>PROBLEM</b>	<b>CAUSE</b>	<b>REMEDY</b>
1. The tub will not rotate, and the sensor light is not lit.	<ol style="list-style-type: none"><li>1. The sensor gap is out of adjustment.</li><li>2. There is a broken wire on the wiring harness.</li><li>3. The sensor is faulty.</li><li>4. The sensor light bulb is faulty.</li><li>5. The electronic governor is faulty.</li></ol>	<ol style="list-style-type: none"><li>1. Readjust the sensor gap to 3/32". This is roughly the thickness of a nickel.</li><li>2. Repair or replace the wiring harness.</li><li>3. Test and replace the sensor as necessary.</li><li>4. Replace the sensor light bulb</li><li>5. Replace the electronic governor.</li></ol>
2. The tub will not rotate, and the sensor light is lit.	<ol style="list-style-type: none"><li>1. The tub limit knob is turned fully counterclockwise.</li><li>2. The manual hydraulic valve is in the neutral position.</li><li>3. The electronic governor is faulty.</li></ol>	<ol style="list-style-type: none"><li>1 Adjust the tub limit knob clockwise.</li><li>2 Engage the manual hydraulic valve.</li><li>3. Replace the electronic governor.</li></ol>



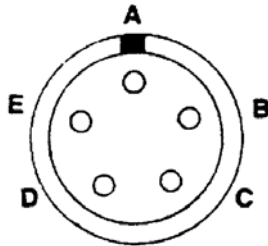
## ELECTRONIC GOVERNOR HARDWARE TEST



**NOTE:** HD-10P series V contain 24 volt systems.

1. Power source: 24 volts DC  
Red wire + positive pin A wiring harness  
Black wire - Negative Pin B wiring harness
2. Test output voltage to valve DC  
Red wire + positive pin D wiring harness.  
Black wire - negative pin E. wiring harness.

figure 7.1  
electronic governor  
wiring harness



**A - 24 volts DC ignition**  
**B - Ground**  
**C - Digital sensor signal\***  
**D - 0 to 24 volts ( + ) to valve**  
**E - 0 ( - ) to valve**

Test the electronic governor with power supplied to the governor control box and the mode switch set to the tub position. The grinder does not need to be running for this test. Disconnect the wiring harness at the valve. With a voltmeter set for 24 volts DC, connect the red lead of the voltmeter to the red lead of the wiring harness and black lead to the black wire. Turn the tub limit knob until the left speed light (turtle) is on. The voltmeter should read approximately 6 volts. Turn the tub limit knob clockwise. As more speed lights light up, the voltage should increase. Turn the knob until the right speed light (Rabbit) is lit. The volt meter should now read a minimum of 18 volts.

3. Output voltage of sensor AC  
red wire - Pin C wiring harness  
Black wire - Pin B wiring harness.

Set the sensor gap to 3/32".

Remove the wiring harness from the electronic governor.

With the engine at operating temperature and the clutch engaged, throttle the engine up to the desired engine RPM.

With volt meter set to AC volts, connect leads to pins B and C. The volt meter should read 2 to 3 volts AC.



## ELECTROHYDRAULIC VALVE COIL TEST

See the figure 7.2 for the location of the electro-hydraulic valve coil.

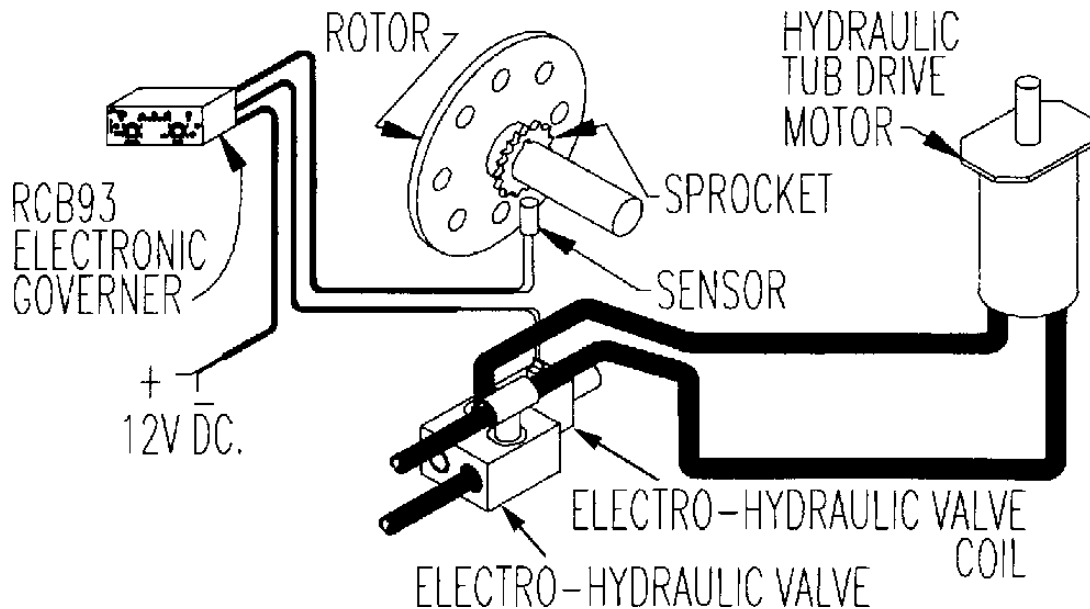
This test requires an accurate ohm meter. Disconnect the wiring harness leads at the electro-hydraulic valve coil. Check resistance of valve coil leads at the terminals. The resistance should be between 8 to 12 ohms for a 12 volt system, and between 39 to 44 ohms for a 24 volt system.. If the values are not within this range, replace the electro-hydraulic valve coil.

## MANUAL OVERRIDE



**NOTE:** If there is an electrical failure with the machine, it may still be able to grind. Switch the electronic governor off. Remove the rubber end cap and loosen the jam nut on the electro-hydraulic valve. Start the machine and engage the tub drive.

figure 7.2  
electronic governor  
system



**IMPORTANT! - DO NOT ENGAGE THE ROTOR CLUTCH AT THIS TIME!**

Turn the adjusting stud clockwise until the tub rotates at the desired speed. Lock the jam nut on the adjusting stud and replace the rubber end cap on the electro-hydraulic valve. When the electro-hydraulic valve is adjusted in this manner, it will function only as a manual flow control. The tub speed will be constant and it will not change to match varying load conditions.

Contact your dealer for repairs or replacement parts. When the problems are corrected, calibrate the electro-hydraulic valve.



## 6.2 General Troubleshooting

table 7.3  
general troubleshooting

1. No grinding capacity	<ol style="list-style-type: none"> <li>1. The screen is plugged.</li> <li>2. The hammers or screens are badly worn.</li> <li>3. Materials are too light or fluffy.</li> </ol>	<ol style="list-style-type: none"> <li>1. Clean out the holes in the screen.</li> <li>2. Replace or turn worn parts.</li> <li>3. Mix the lighter material with heavier material.</li> <li>4. Use a larger screen.</li> </ol>
2. The tub slows down or turns slowly.	<ol style="list-style-type: none"> <li>1. The electronic governor is not adjusted properly.</li> <li>2. The electronic governor system malfunctions.</li> <li>3. The hydraulic pressure is low.</li> </ol>	<ol style="list-style-type: none"> <li>1. See the sections on the electronic governor in the operations section of this manual.</li> <li>2. See Troubleshooting the electronic governor in this manual.</li> <li>3a. Check oil pressure.</li> <li>3b. Look for internal leakage or wear in the orbit motor or pump.</li> </ol>
3. The machine vibrates excessively.	<ol style="list-style-type: none"> <li>1. A hammer is broken.</li> <li>2. The rotor bearing is defective.</li> <li>3. The driveline is worn or misaligned.</li> <li>4. Foreign material is wrapped in the rotor.</li> <li>5. The hammer pattern is incorrect.</li> </ol>	<ol style="list-style-type: none"> <li>1. Replace the broken hammer. See page 55 for more information about replacing hammers.</li> <li>2. Replace the rotor bearing.</li> <li>3. Replace worn part or the complete driveline.</li> <li>4. Remove the foreign material.</li> <li>5. See page 55 for more information about hammer patterns.</li> </ol>
4. The engine loses excessive RPM's before the tub stops.	<ol style="list-style-type: none"> <li>1. The electronic governor is not adjusted properly.</li> </ol>	<ol style="list-style-type: none"> <li>1. See the sections on the electronic governor in the operations section of this manual.</li> </ol>
5. The tub stalls.	<ol style="list-style-type: none"> <li>1. The tub hydraulic system, pressure relief valve is set too low.</li> <li>2. The tub is overloaded due to wet or tough grinding materials.</li> <li>3. Too much material in the tub.</li> <li>4. The tub is binding.</li> <li>5. The hydraulic oil is too hot causing electronic governor valve to bind.</li> </ol>	<ol style="list-style-type: none"> <li>1. Readjust the pressure relief valve to 2,500 PSI max.</li> <li>2. Reduce amount of material in tub or shift the hydraulic tub drive to low range.</li> <li>3. Reduce the amount of material in tub.</li> <li>4. Remove material buildup between the tub and the platform framework.</li> <li>5. Reduce the load on the hydraulic system, or stop and allow the hydraulic oil to cool.</li> </ol>
6. The hydraulic oil overheats.	<ol style="list-style-type: none"> <li>1. Pressure relief valve in control valve is faulty.</li> <li>2. The tub is overloaded.</li> <li>3. Worn pump, control valve, hyd. motors, etc.</li> </ol>	<ol style="list-style-type: none"> <li>1. Check oil pressure.</li> <li>2. Reduce the amount of material in the tub.</li> <li>3. Rebuild or replace the hydraulic components as necessary.</li> </ol>



## 6.3 Troubleshooting Microtronics wireless remote controls

### Manual / Remote Switch

Check operation of the tub grinder with the manual / remote switch in the “manual” position before troubleshooting the wireless remote control system. If the grinder functions properly in “manual” position and will not function properly in the “remote” position then proceed with troubleshooting of the remote control system. If the grinder will not function in the “manual” position, the problem is not in the wireless remote system.

### Transmitter Battery

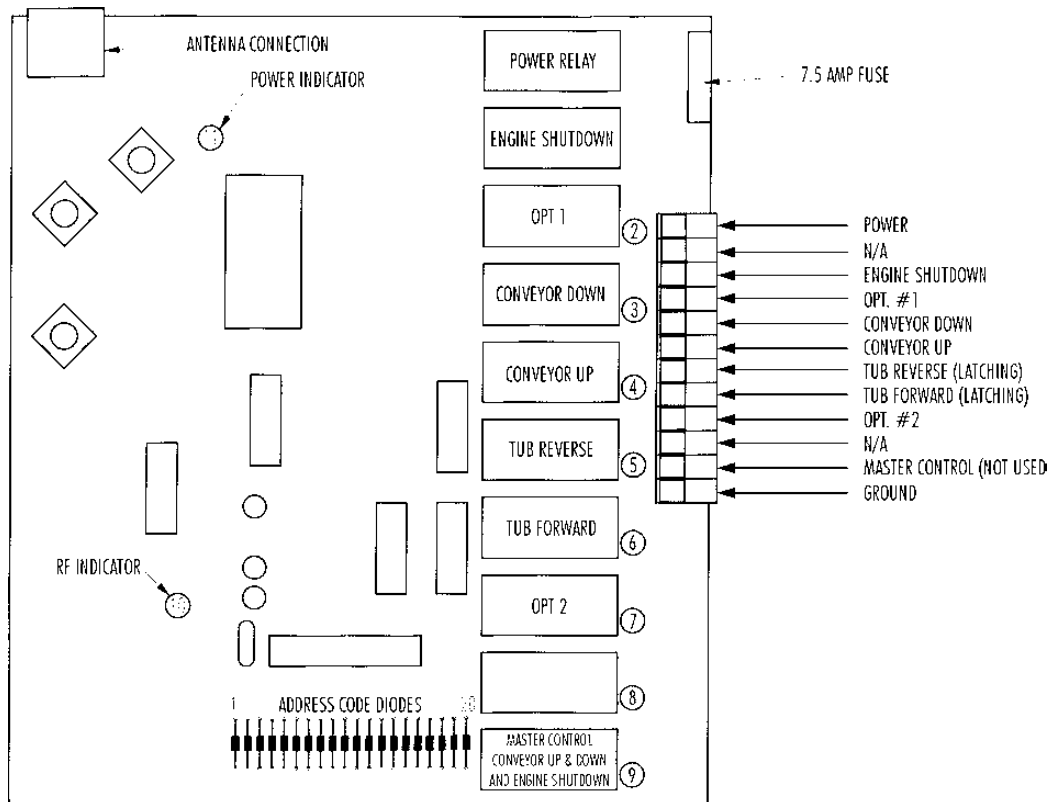
The transmitter is powered by a 9 volt battery. Replace battery with alkaline 9-volt battery. Do not use rechargeable nicad or “Heavy Duty” rated batteries. Remove the battery cover on the lower back of transmitter housing. Plug the 9-volt battery to the battery clip and install inside the chassis. Replace battery cover and you are ready to use the transmitter.

To operate the transmitter, push any switch for desired operation. There is no battery drain on the transmitter when a button is not pushed. If transmitter is not to be used for long periods of time, remove the battery.

### Receiver

The receiver is mounted in the control panel enclosure on the front end of the grinder. It is a white metal box with 4 screws on the cover. A manual / remote switch is located on the operations control panel on the front of the engine. Power is supplied to the receiver only when this switch is placed in the “remote” position.

figure 6.3  
wireless remote receiver  
circuit board







## Receiver Power Check

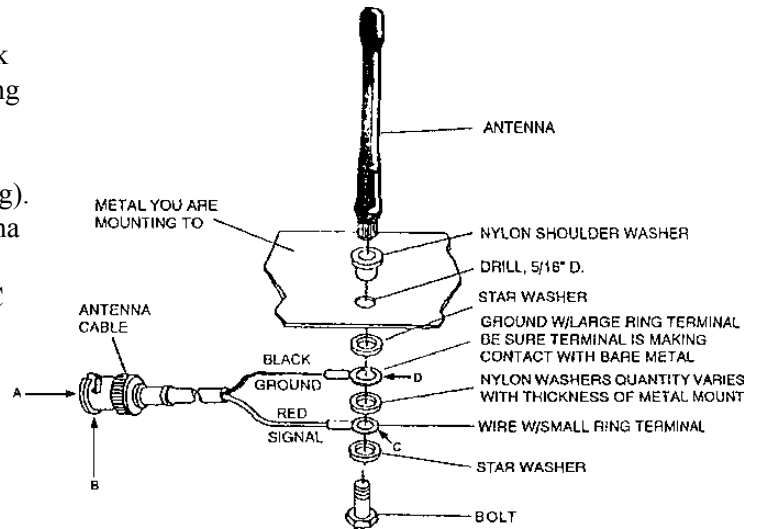
Remove the cover to the receiver and locate the power indicator lamp (11). Place the manual / remote switch in the “remote” position and turn the engine keyswitch to the “run” position (do not start the engine!). The power indicator lamp (11) should come on. If it does not come on, check the 7.5 amp fuse found in the upper right hand corner of the receiver box. If the fuse is good, check for wiring continuity from the manual / remote switch to the radio receiver. 12 volts DC should be available at the power terminal inside the receiver enclosure.

## Receiver / Transmitter Communication Check

If the power indicator lamp (11) is on, then proceed to test the remote functions. Begin by pressing and holding the ENG button on the transmitter. The RF indicator lamp (10) should come on. When the RF indicator lamp (10) comes on, that is proof that the transmitter is sending a signal and the receiver is receiving the signal. This is true for any of the functions available on the transmitter. If the RF indicator lamp fails to come on, remove the power supply to the receiver and wait for 30 seconds. Connect the power to the receiver and retest. If the RF indicator lamp (10) still does not come on, check the antenna connections and cable.

## Antenna and Cable Check

Disconnect the antenna cable from the receiver. Use an ohmmeter set on the minimum resistance scale and check for continuity of the antenna cable leads. (See the drawing at right.) There should be no continuity (maximum resistance reading) between A and B. There should be continuity between A and C (minimum resistance reading). There should be continuity between B and D. The antenna cable at point D should be grounded to the antenna mounting surface. There should be no contact between C and D or between C and “ground”



If the transmitter battery is good and the antenna assembly appears to be functioning correctly but a signal is not recognized by the receiver [RF indicator lamp (10) comes on when a signal is recognized], replace the transmitter and receiver or return the transmitter and receiver to DuraTech.

## Engine Shutdown Check

Once again press and hold the ENG button on the transmitter. The RF indicator lamp (10) and the master control indicator lamp (9) should come on. Also, the engine shutdown relay will close but there is not an indicator lamp to verify this. Visually observe the contacts in the engine shutdown relay to see that they open and close when you press and release the ENG button on the transmitter. Continuity can be checked by probing the engine shutdown terminal and the ground terminal while pressing and holding the ENG button on the transmitter. If there is continuity when you press the ENG button then this portion of the remote control is functioning properly.



## Conveyor Up and Down Check

Press and hold the CONV UP button on the transmitter. The RF indicator lamp (10), the master control indicator lamp (9), and the conveyor up indicator lamp (4) should come on. Press and hold the CONV DOWN button on the transmitter. The RF indicator lamp (10), the master control indicator lamp (9), and the conveyor down indicator lamp (3) should come on. A voltmeter set to read 12 volts DC can be used on the terminal strip to see if voltage is present by probing the conveyor up and conveyor down terminals and the ground terminal while pressing and holding the coinciding button on the transmitter. If either one of these functions is not operating (voltage not present at the terminal) the wire could be transferred to OPT. #1 or OPT. #2 terminal. Use the OPT. #1 or #2 button on the transmitter to operate that function. [ Opt. #1 and Opt. #2 are spare momentary functions.]

## Tub Forward and Tub Reverse Check

Press and release the TUB FWD button on the transmitter. The RF indicator lamp (10) and the tub forward indicator lamp (6) should come on. Press and release the TUB FWD button again and the RF indicator lamp (10) and the tub forward indicator lamp (6) should turn off. Press and release the TUB FWD button again and test the terminal strip to see if 12 volts DC is present by probing the tub forward terminal and the ground terminal. Press and release the TUB FWD button again so the indicator lamps turn off and no voltage should be present when probing the tub forward and ground terminals.

Press and release the TUB REV button on the transmitter. The RF indicator lamp (10) and the tub reverse indicator lamp (5) should come on. Press and release the TUB REV button again and the RF indicator lamp (10) and the tub reverse indicator lamp (5) should turn off. Press and release the TUB REV button again and test the terminal strip to see if 12 volts DC is present by probing the tub reverse terminal and the ground terminal. Press and release the TUB REV button again so the indicator lamps turn off and no voltage should be present when probing the tub reverse and ground terminals.

Press and release the TUB FWD button so lamp (6) is on. Press TUB REV once and lamp (6) should go off. Press TUB REV a second time and lamp (5) should come on. Press the TUB FWD button once and lamp (5) should turn off. Press TUB FWD again and lamp (6) should come on.

If all of the output functions appear to be operating correctly the wireless radio remote control is performing as expected. If problems continue, the cause may be in the wiring, connections, or components that the radio control operates.

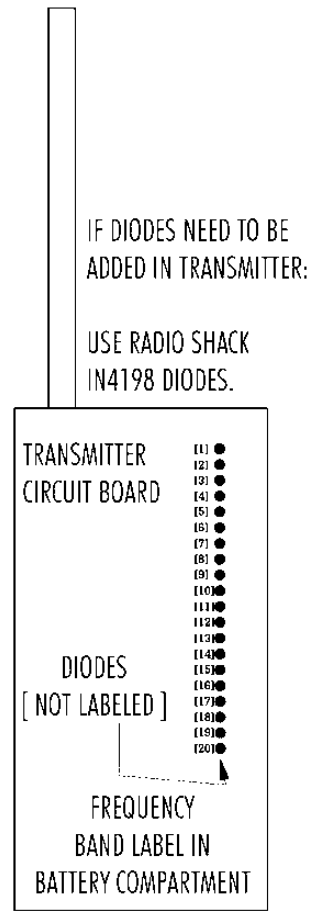
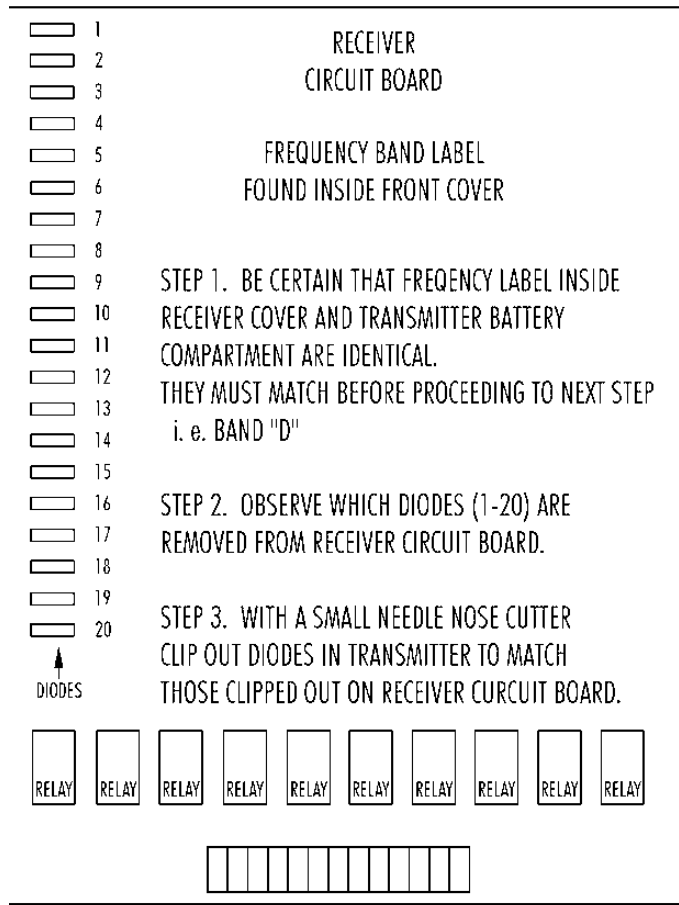
If the problem appears to be in the radio control transmitter or receiver, replace both components or return both components to DuraTech for repairs. Replacement transmitters (C band part no. 5700308 or D band part no. 5700257) can be obtained from DuraTech to replace lost or damaged transmitters. Address codes can be matched to the existing radio receiver by removing the appropriate diodes from the transmitter circuit board to match your previous transmitter. **See figure 6.4.**

Replacement transmitters and receivers are sold only in matched sets so the address codes match correctly.

12V DC kit replacement radio kit part number is 5700224.



figure 6.4  
 matching receiver and  
 transmitter frequencies (for  
 tub forward/reverse check  
 refer to figure 6.3)





## 6.4 Troubleshooting Omnex Wireless Remote Controls

The OMNEX ORIGA is a portable, long range, programmable, 8-channel radio remote control unit for 10 to 32VDC operated fixed and mobile equipment. Designed as a safe, compact and easy-to-use radio remote control, the ORIGA puts complete control where it is needed most: with the operator.

### TROUBLESHOOTING THE OMNEX ORIGA

#### THE REMOTE RADIO CONTROLLER (T100)/TRANSMITTER

<b>SYMPTOM</b>	<b>POSSIBLE CAUSE</b>	<b>REMEDY</b>
Flashing red LED	Battery power level is less than 20%	Replace batteries
Flashing red and yellow LEDs	T100(remote controller) is in Program mode	Press red button to close Program mode
Yellow LED does not flash when buttons 1-8 are pressed.	T100 not activated / Batteries are dead	Initiate appropriate power on sequence / Replace batteries
Yellow LED flashes when button is pressed, but machinery does not respond to the commands.	Out of Range	Relocate closer to the machinery

#### THE REMOTE RADIO RECEIVER (R100e)

<b>SYMPTOM</b>	<b>POSSIBLE CAUSE</b>	<b>REMEDY</b>
Out LED is extinguished	No power to the R100e (Receiver)	Check power source
SETUP Yellow LED illuminated	R100e is in Program mode	Allow R100e to timeout after 20 seconds
Green LINK LED does not flash when transmitter is ON	R100e does not have the correct ID - not likely on a new system - may occur where either the transmitter or the receiver is replaced individually	Initiate SETUP sequence - see SYSTEM SERVICE
STATUS Red LED is flashing	Incorrect input voltage	Check power source
STATUS Red LED is steady	Permanent internal fault	Disconnect R100e and return unit to manufacturer for repair
STATUS Green LED is flashing	Output shorted	Check wiring
Output LEDs do not light up when activated.	Output shorted	Check wiring, relays, and solenoids



## **PROGRAMMING A REPLACEMENT TRANSMITTER**

To program a replacement transmitter, complete the following steps:

1. Power up the R100E Receiver and verify that the Green Status LED and the Red E-Stop LED are on steady.
2. Power up the T100 Transmitter into Programming Mode by Pressing and holding the RED E-Stop button and then the Green Power Button at the same time. This will power up the T100 into Programming Mode. The Yellow LED to the right of the GREEN Power Button will begin flashing slowly, (once per second).
3. Enter the Programming Password Code by pressing buttons (3, 1, 4, 2) and then press the GREEN Power button once. The Yellow LED to the right of the GREEN Power Button and the Red LED to the left of the GREEN Power button will begin flashing rapidly.
4. Enter the programming values. The programming values for DuraTech are 1266888888.
5. Press and hold the SETUP button on the R100E Receiver (approx. 5 sec.). The Yellow Setup LED will start flashing slowly while the R100E Receiver enters into programming mode. Once the Yellow Setup LED on the R100E Receiver begins to flash rapidly, release the SETUP button. The R100E is now ready to receive the programming information from the T100 Transmitter.
6. Press and release the GREEN Power Button on the T100 to start sending the Programming information to the R100E Receiver. The Green Link LED on the R100E Receiver will begin to flash, and the Green Status LED on the R100E Receiver will be ON steady. Wait for the Link LED to stop flashing, and for the Status LED to begin flashing. This signifies that the programming information has been successfully sent from the T100 Transmitter to the R100E Receiver.
7. Momentarily Power OFF the R100E Receiver and wait for 5 seconds, then power up the R100E Receiver again. The new program settings will now take effect.
8. Press the GREEN Power Button on the T100 Transmitter and observe that the Yellow LED to the right of the GREEN Power Button of the T100 Transmitter will begin flashing. Also note that the Green Link LED on the R100E Receiver is flashing and the Green Status LED on the R100E Receiver is on steady. You are now ready to operate your T100/R100E system.

## **OUT OF RANGE/LOSS OF SIGNAL**

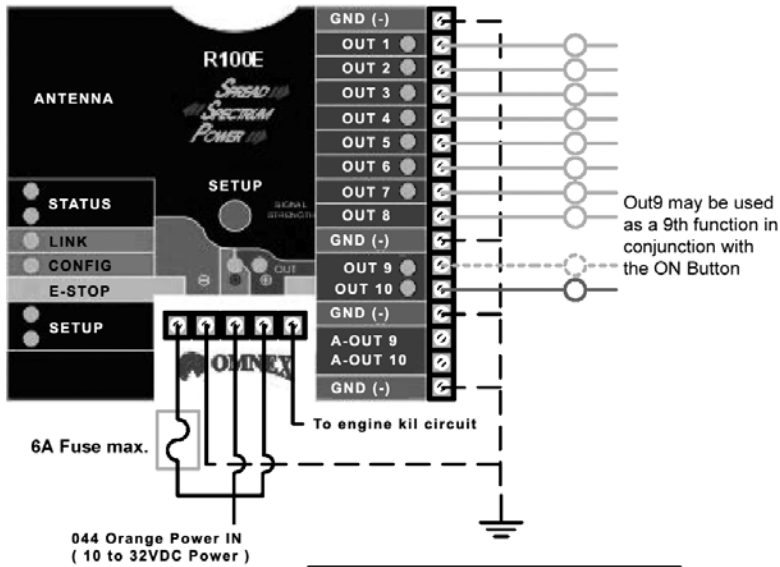
The range of the OMNEX ORIGA is approximately 1,200'. Under certain circumstances, such as low or dead batteries, loss of signal can occur within that distance. In the event that loss of signal occurs, the transmitter will shut off, and the engine will be shut off by the engine kill circuit.



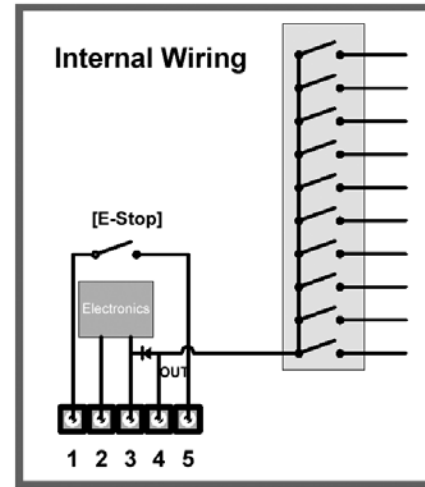
## REPLACING BATTERIES

Install batteries by removing the battery cover using a slotted screwdriver and inserting 4 "AA" Alkaline batteries. Orientation for batteries is embossed inside the battery housing.

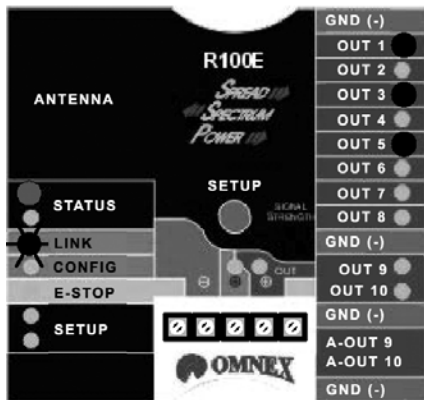
## WIRING SCHEMATIC FOR THE R100e RECEIVER



**NOTE:** Although the Outputs are rated at 10A, the [E-Stop] relay is only 6A and therefore must be fused appropriately



- LED Not Lit ○
- LED Flashing ✖
- LED Lit Constantly ●





## Appendix A: Warranty

DuraTech Industries International Inc. warrants to the original purchaser for 1 year from purchase date that this product will be free from defects in material and workmanship when used as intended and under normal maintenance and operating conditions. This warranty is limited to the replacement of any defective part or parts returned to our factory in Jamestown, North Dakota, USA, within thirty (30) days of failure.

This warranty shall become void if in the judgment of DuraTech Industries International, Inc. the machine has been subject to misuse, negligence, alterations, damaged by accident or lack of required normal maintenance, or if the product has been used for a purpose for which it was not designed.

All claims for warranty must be made through the dealer which originally sold the product and all warranty adjustments must be made through same.

This warranty does not apply to tires or bearings or any other trade accessories not manufactured by DuraTech Industries International Inc. Buyer must rely solely on the existing warranty, if any, of these respective manufacturers.

DuraTech Industries International Inc., shall **not** be held liable for damages of any kind, direct, contingent, or consequential to property under this warranty. DuraTech Industries International Inc., cannot be held liable for any damages resulting from causes beyond its control. DuraTech Industries International Inc., shall **not** be held liable under this warranty for rental costs or any expense or loss for labor or supplies.

DuraTech Industries International Inc., reserves the right to make changes in material and/or designs of this product at any time without notice.

This warranty is void if DuraTech Industries International Inc. does not receive a valid warranty registration card at its office in Jamestown, North Dakota, USA, within 10 days from date of original purchase.

All other warranties made with respect to this product, either expressed or implied, are hereby disclaimed by DuraTech Industries International Inc.



# Appendix B: SPECIFICATIONS

## General

Weight .....	28,100 lbs.
Transport Width .....	10' (120")
Transport Height .....	10' 8" (128")
Transport Length with folded conveyor .....	27' 5" (329")
Axle .....	(2)-15,000 lb. axle
Tires .....	(8)-215/75 R17.5
Brakes .....	Air brakes
Weight on Hitch Point .....	4600 lbs.
Fuel Capacity .....	168 U.S. gallons
Hydraulic Oil Capacity .....	45 U.S. gallons
Lights .....	Clearance, directional, and tail lights

## Tub features

Tub Width .....	10'
Depth .....	46"
Tub Diameter at base .....	95"
Tub Wall .....	1/4" thick
Tub Floor .....	3/8" thick
Tub Drive .....	Dual hydraulic orbit motors direct drive chain
Service Access .....	90° hydraulic tilting tub
Discharge Conveyor .....	22'(l) x 24"(w) x 8"(d), hydraulic end driven cleated belt
Belly Conveyor .....	30" wide hydraulic end driven cleated belt
Tub Speed Sensor .....	Electronic self-governing
Safety Switches .....	Safety shutdown
.....	Automatic shutdown if tub lifts while the rotor is spinning
.....	Engine will not start with the rotor clutch engaged

## Hammermill

Hammer Size .....	3/4" hardened swing hammers
Rotor - Shaft diameter .....	4-1/2" Stress proof steel
Rotor Length .....	44"
Rotor Plates .....	16" diameter x 1" thick
Feed Opening .....	25" x 45"
Screen Area .....	2403 sq. in.
Screens Split screens .....	Split screens 1" thick- avail. in various hole sizes
Hammer Rods .....	1-1/4" x 43" case hardened rods
Bearings .....	3-1/2" oil bath pillow block bearings
Hammermill Drive .....	Direct drive with torque limiter





## **Options**

- Radio remote that features the following commands; tub start-stop, tub forward-reverse, conveyor up-down, tub cover raise/lower (optional) and emergency stop.
- Magnetic roller with aluminum deflector
- Engine block heater
- Tub cover
- Magnetic roller with folding aluminum deflector for machines equipped with a tub cover





## **Notes:**



